

ELP21LU1

SINGLE CHANNEL CONTROLLER

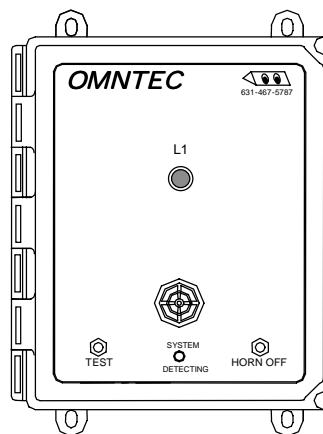
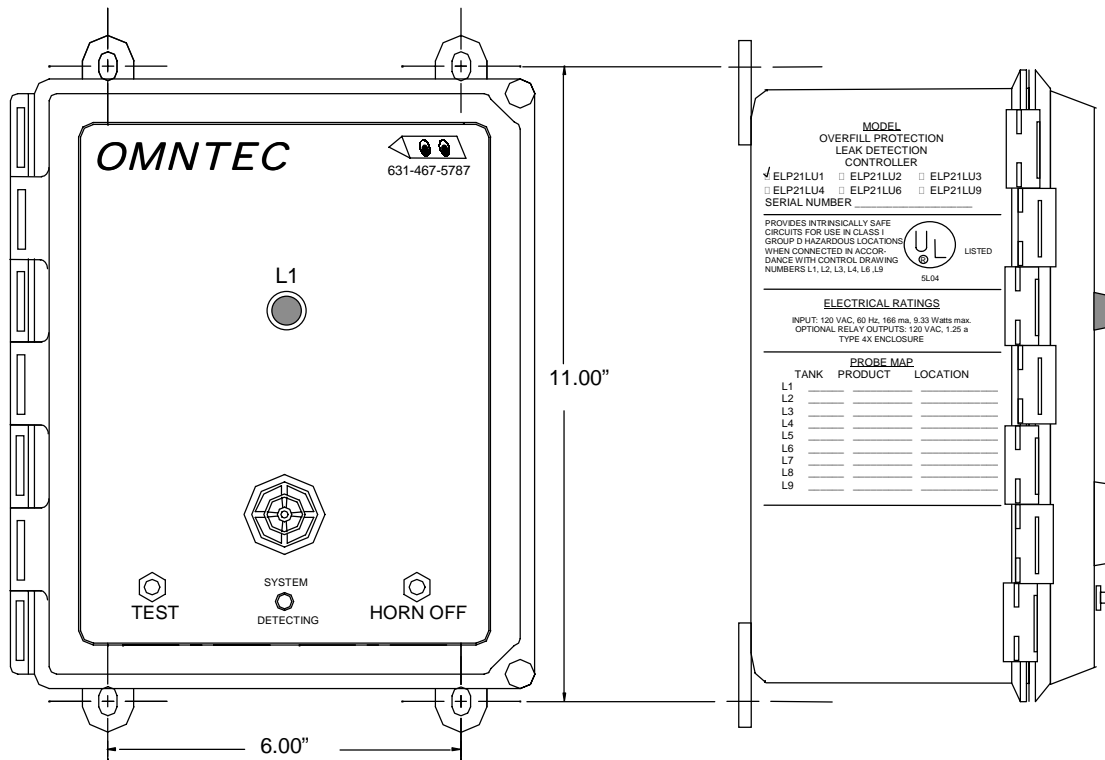

Table of Contents

Specifications	3
LU-series Installation Instructions	4
L-series	4
LS-ASC Sensor	5
LWF-* Sensor	6
Control Unit.....	7
LU1 Wiring Diagram	8
Control Drawing	9
LS-ASC	10
L-1	11
LWF	12
RA-series Remote Annunciators	13
LU-series System Operation and Test Instructions	14
LU-series Troubleshooting Procedures	15
Log Sheet	18
Warranty.....	19

SINGLE CHANNEL



SPECIFICATIONS

POWER INPUT

85-125 VAC, 47-440 Hz
16 Watts maximum

POWER TO SENSORS

2 VDC @ 13 ma

RELAY OUTPUT

SPST normally open dry contacts 1.25 AMPS, 120 AC/DC switches when an alarm condition occurs

WEIGHT

6 LBS.

DIMENSIONS

(W) 9" x (H) 10.5"

SENSOR CABLE

Shielded 22 AWG UL-E118830 CM
Maximum length 2000 feet

ENCLOSURE

NEMA 4X

OPERATING TEMPERATURE

-40° to 140° F

UL LISTED

Intrinsically safe circuits for use in class I group D hazardous locations when connected in accordance with control drawings L1

AUDIO/VISUAL CONSOLE

AUDIBLE ALARM - 95 dB pulsing horn with 30 second timeout

RED LIGHT - Indicates liquid alarm for L-series sensors

TEST BUTTON - When pressed will actually test entire system electronics from control panel to sensors

GREEN LIGHT - indicates the power is on

HORN OFF BUTTON - Silences the audible alarm when pressed

SENSORS

L-1 High level sensor

LS-ASC Liquid sensor

LWF Double wall liquid sensor

ACCESSORIES

RA-1 audio/visual remote annunciator

RLY-RA Relay (consult factory)

RA-1-NYS Remote annunciator with strobe (consult factory)

LABELS

Provided with controller

LU-series Installation Instructions

READ ALL INSTRUCTIONS PRIOR TO SYSTEM INSTALLATION. ALL WIRING IS TO BE DONE IN ACCORDANCE WITH ALL NATIONAL AND LOCAL ELECTRICAL CODES. POWER IS TO BE OFF DURING ANY WIRING. WIRE AND TEST ENTIRE SYSTEM BEFORE UTILIZING SK-1 CONNECTOR SEALING KITS. STANDARD EQUIPMENT IS COMPATIBLE WITH MOST PETROLEUM PRODUCTS. SOME CHEMICAL AND SOLVENTS REQUIRE SPECIFIC MATERIALS OF CONSTRUCTION. IF UNSURE OF COMPATIBILITY CONTACT MANUFACTURER.

I. L-SERIES PROBE

A. L-1 SENSOR

The L-1 sensor (*see pg.9*) is primarily used to detect a liquid level inside the tank. The sensor detects a single liquid level and is typically used for overflow protection at 90% tank capacity. Standard sensor part numbers are L-1-S (12"), L-1-L (20"), L-1-D (custom length).

The L-1 sensor is installed into the tank via the 2" bushing which is an integral part of the sensor. This sensor threads directly into a 2" female threaded NPT (use a reducer bushing if necessary).

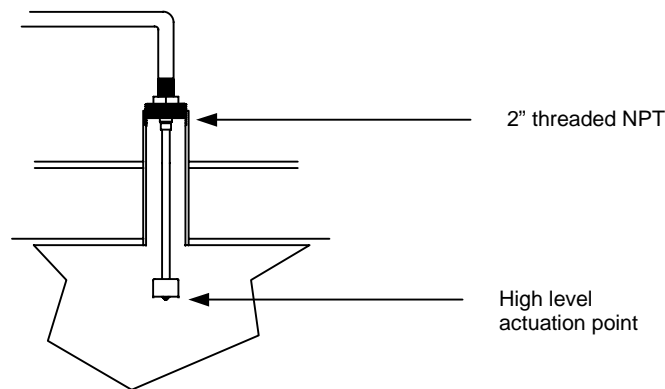

Connection of the sensor to the control unit cable is made in a junction box. For detailed wiring scheme refer to appropriate drawing (*see pg.6 and 7*). These connections must be made using supplied SK-1 wire sealing kit.

B. LS-ASC SENSOR

The LS-ASC sensor (*see pg.8*) is designed to detect liquid in sumps or containment areas and steel interstitial spaces for above ground and underground tanks.

1. To install the LS-ASC sensor as an above ground sump sensor mount a junction box between 2 and 3 feet above bottom of containment area. Attach sensor to junction box via conduit or cable clamp, leaving a $\frac{1}{4}$ " clearance between the sensor end and the bottom of the containment area. For detailed wiring scheme refer to appropriate drawing (*see pg.6 and 7*). Connect sensor cables to control unit cables in junction box using supplied SK-1 wire sealing kit.

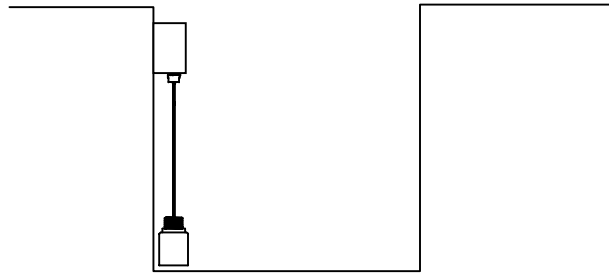

2. To install the LS-ASC as a doublewall tank sensor remove the oiltight from the sensor cable. Feed the cable through the appropriate bushing required to adapt the interstitial port to $\frac{3}{4}$ " NPT (oiltight). Feed wires through oiltight, leaving it loose. Gently lower sensor down interstitial port until it rests on the bottom. Install oiltight into the bushing. Pull sensor up by the cable until it just comes off the bottom. Maintain this position and tighten the oiltight fitting. This is required to seal the interstitial port. All wire connections are made using the supplied SK-1 wire sealing kit.

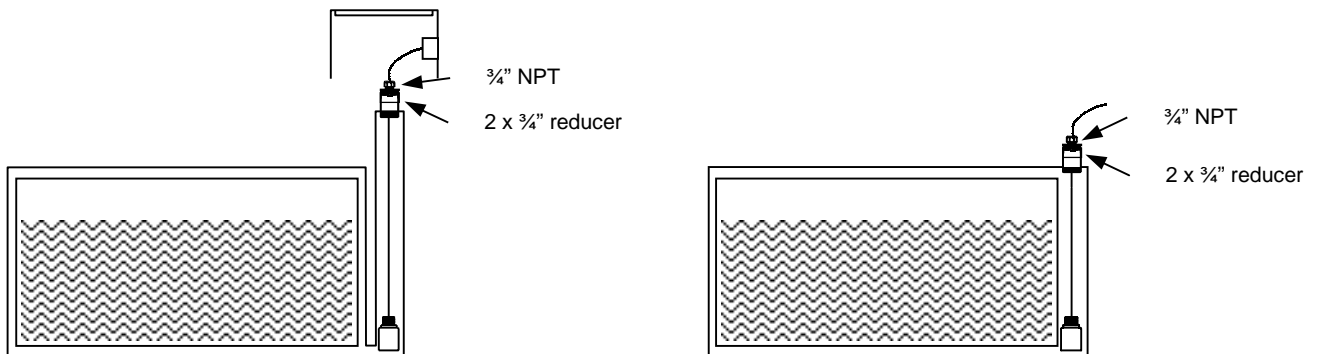

C. LWF-* SENSOR

LWF-* sensor (*see pg.10*) is designed to detect liquid in the interstitial space of a dry double wall fiberglass tank.

1. The LWF-* sensor is installed through the interstitial port. If the tank is pitched, locate the interstitial sensor at lowest elevation of tank. Insert sensor into the interstitial port and push down around outside of inner tank. When PVC handle contacts the inner tank the sensor should be located at the bottom of interstitial space. Reduce the riser to 3/4" NPT and install the supplied oiltight fitting. The oiltight fitting must be installed to prevent liquids from entering the interstitial space. Run conduit from interstitial man hole to the central junction box, located in the manway sump. Install a second oiltight on the sensor cable and pull sensor cable through conduit. Connect oiltight to conduit and tighten. For detailed wiring scheme refer to appropriate control drawing (*see pg.6 and 7*). Connect sensor wires in central junction box to control unit cable(s) and use SK-1 wire sealing kit.

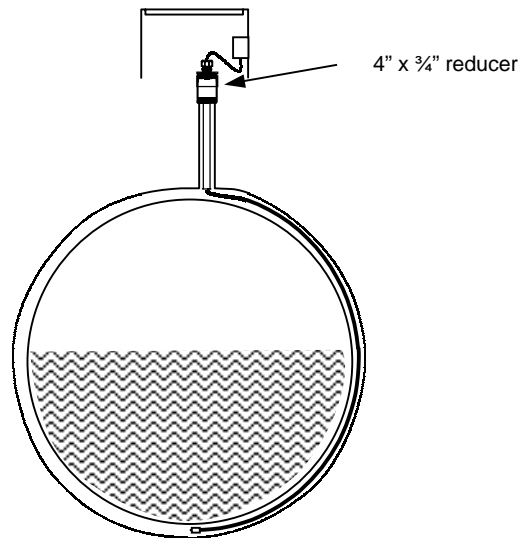

II. CONTROL UNIT

The control unit (*see pg. 1*) should be mounted in a manned area. Route sensor control cable through conduit from the junction box to the control unit. Sensor control cables enter the control unit through the output port only. The cables are wired as shown in the appropriate drawing (*see pg. 6*). The control unit accepts any possible combination of L-series sensors.

INPUT POWER HOOKUP

Input power requirements are:
85 – 125 VAC
16 Watts max
47 – 440 Hz

Input power cable should be wired in accordance with all pertinent electrical codes. This cable should enter the control unit through the input power port only. Remove protective plastic power supply cover allowing access to screw terminals. The power is hooked up to the power supply and wired as per control drawing (*see page 7*). NOTE: EARTH GROUND TERMINAL MUST BE CONNECTED.

REMOTE ANNUNCIATOR OPTION

Mount remote annunciator (*see pg. 11*) within audio / visual range of the filling operator. NOTE: the remote must be outside of the HAZARDOUS AREA. Pull appropriate low voltage wire from the remote to the control unit. See appropriate drawing for wiring details. Run wires through output port. Connect color coded wires.

SK-1 WIRE SEALING KIT

Make all splices using SK-1 wire sealing kit (supplied).

ELP21LU1

CONTROLLER CONNECTION DIAGRAM

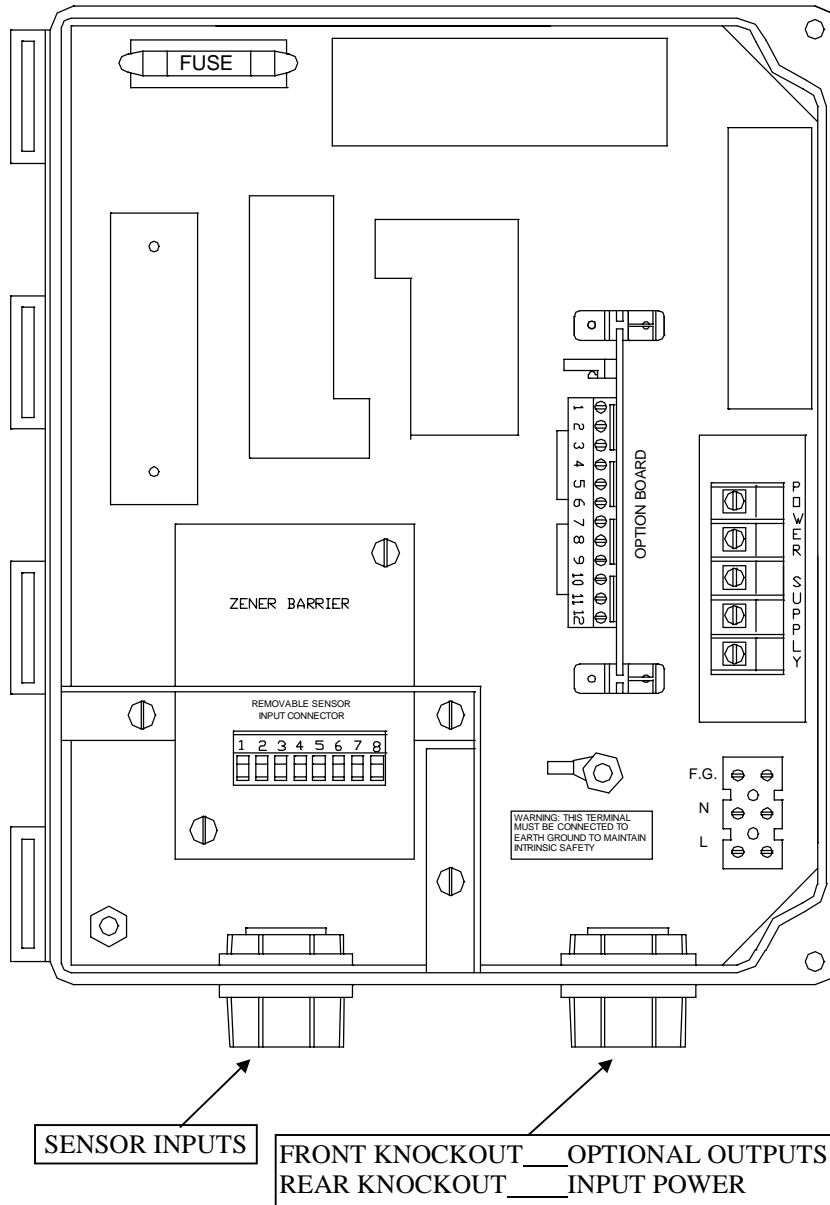

COLOR CODE

CABLES FROM SENSORS TO REMOVABLE SENSOR INPUT CONNECTORS

1	RED	SENSOR #1
2	WHITE	
3	UNUSED	
4	UNUSED	
5	UNUSED	
6	UNUSED	
7	BLACK	FROM SENSOR #1
8	SHIELD DRAIN	FROM SENSOR #1

WIRES TO OPTION BOARD

WIRES FROM RA-SERIES REMOTE

1	GREEN	-HORN
2	RED	+HORN
3	BLACK	GROUND
4	WHITE	SENSOR #1
5	UNUSED	
6	UNUSED	

WIRES FROM RELAY OUTPUTS

7	UNUSED	
8	UNUSED	
9	UNUSED	
10	UNUSED	
11	COMMON	SENSOR #1
12	NORMALLY OPEN	

120VAC

WIRES TO POWER SUPPLY

F.G.	FIELD GROUND
L	LINE
N	NEUTRAL

NOTE: To maintain proper shielding, BLACK sensor wires and SHIELD DRAINS should **not** be connected together at sensors.

ELP21LU1 SYSTEM CONTROL DRAWING

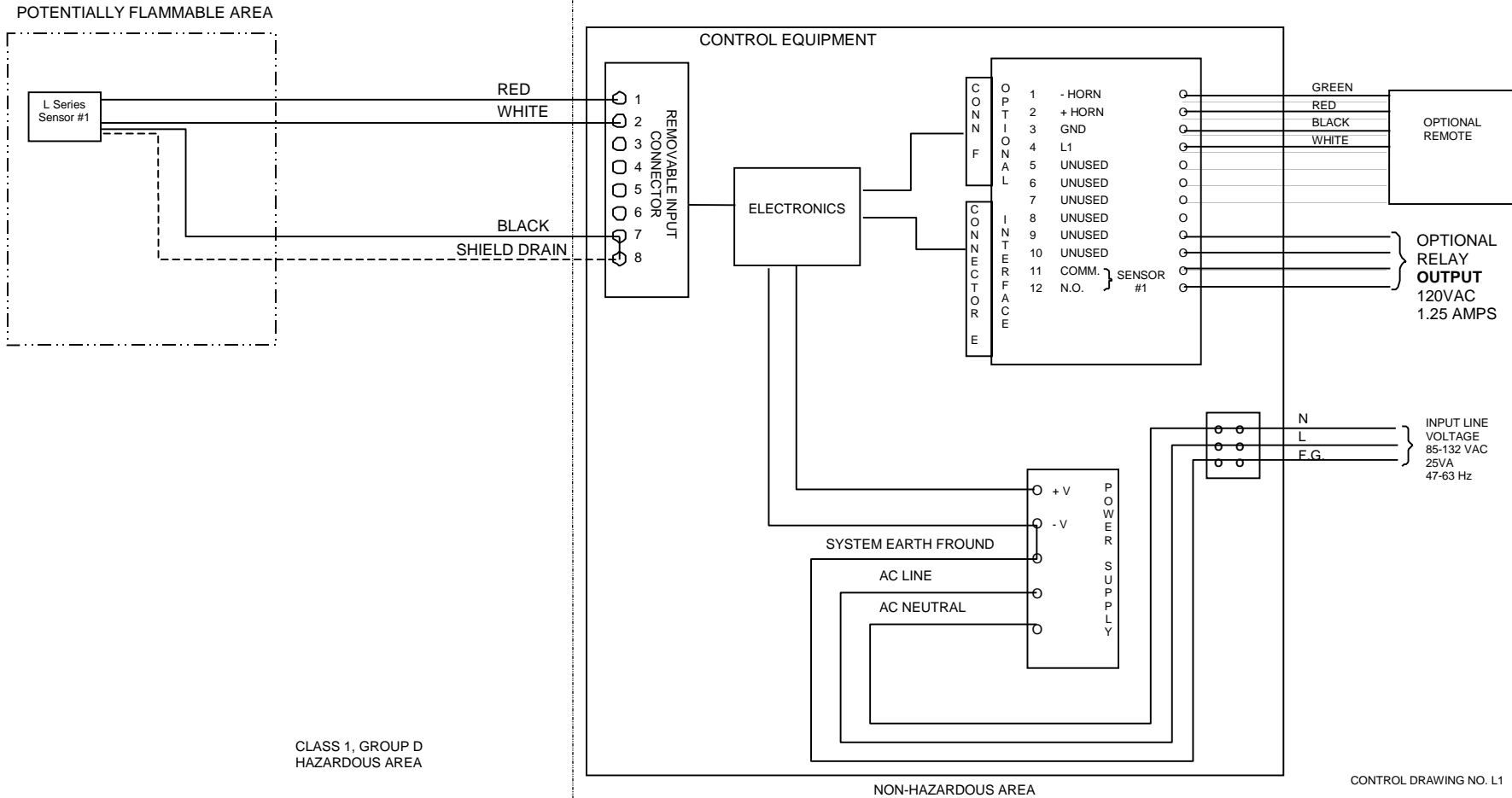

NOTES ON PROBES

1. THE INTRINSICALLY SAFE FIELD WIRING SHALL BE INSTALLED IN ACCORDANCE WITH ARTICLE 504 IN THE NATIONAL ELECTRIC CODE ANSI/NFPA 70
2. ALL PROBES ARE ELECTRICALLY IDENTICAL AND MAY BE INTERCHANGED ALLOWING SYSTEM FLEXIBILITY
3. PROBE TO CONTROL UNIT CABLE WILL BE TWO PAIR OF #22AWG WITH SHIELD AND DRAIN PVC JACKETED UL-118830 CM. CABLE LENGTH WILL BE LIMITED TO 2000 FEET MAXIMUM

NOTES ON CONTROL EQUIPMENT

1. ALL WIRING MUST MEET LOCAL AND NATIONAL ELECTRICAL CODES
2. SYSTEM EARTH GROUND MUST BE CONNECTED TO TERMINAL F.G. TO INSURE INTRINSIC SAFETY AND MUST BE LESS THAN 1Ω WITH RESPECT TO EARTH GROUND
3. OPTIONAL REMOTE REQUIRES #22 AWG LOW VOLTAGE COMMUNICATION CABLE MINIMUM

Non-product distinguishing Optic Sensor

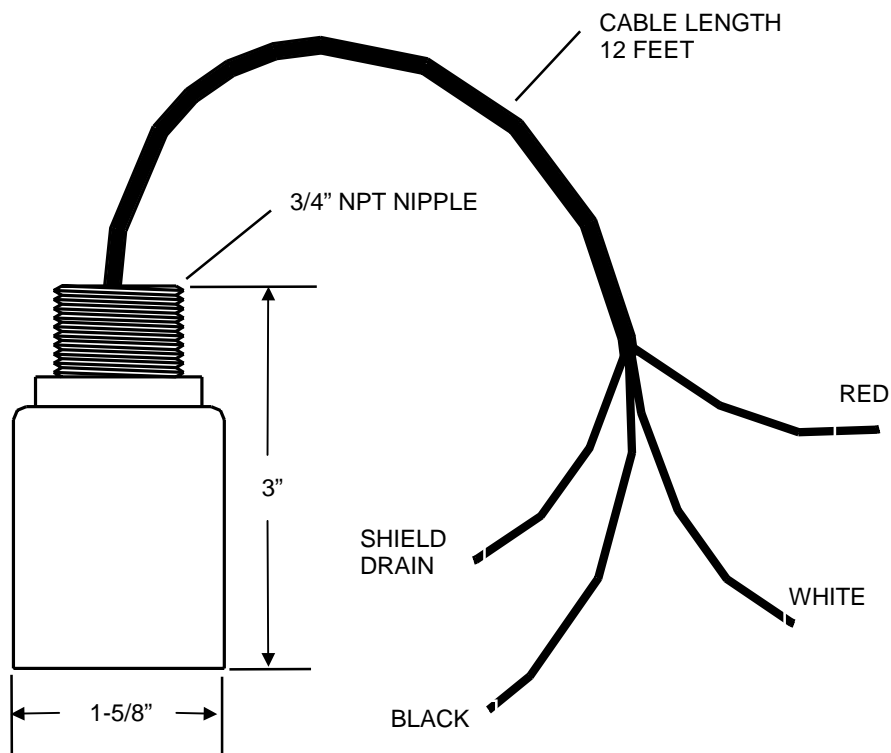
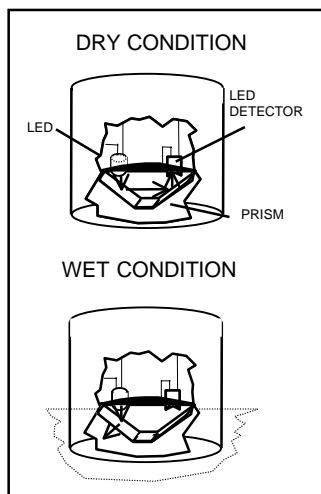

SPECIFICATIONS

U.L. LISTED 5L04

Intrinsically safe Class I, Group D Hazardous Locations when connected in accordance with control drawing nos. L1, L2, L3, L4, L6, L9

OPERATING TEMPERATURE

-40 TO +140 F

POWER

2 VDC @ 13 mA

WEIGHT

1/2 pound

PRINCIPLES OF OPERATION

LIQUIDS (ex: fuel, water) – photo Optic
 DRY CONDITION – Normally closed light beam
 ALARM CONDITION – Opens (refracts) normally closed light beam

SENSOR CABLE

Shielded 22 AWG UL-E118830 CM
 Maximum length 2000 feet

RESPONSE TIME

Immediate

Liquid Level Optic Sensor

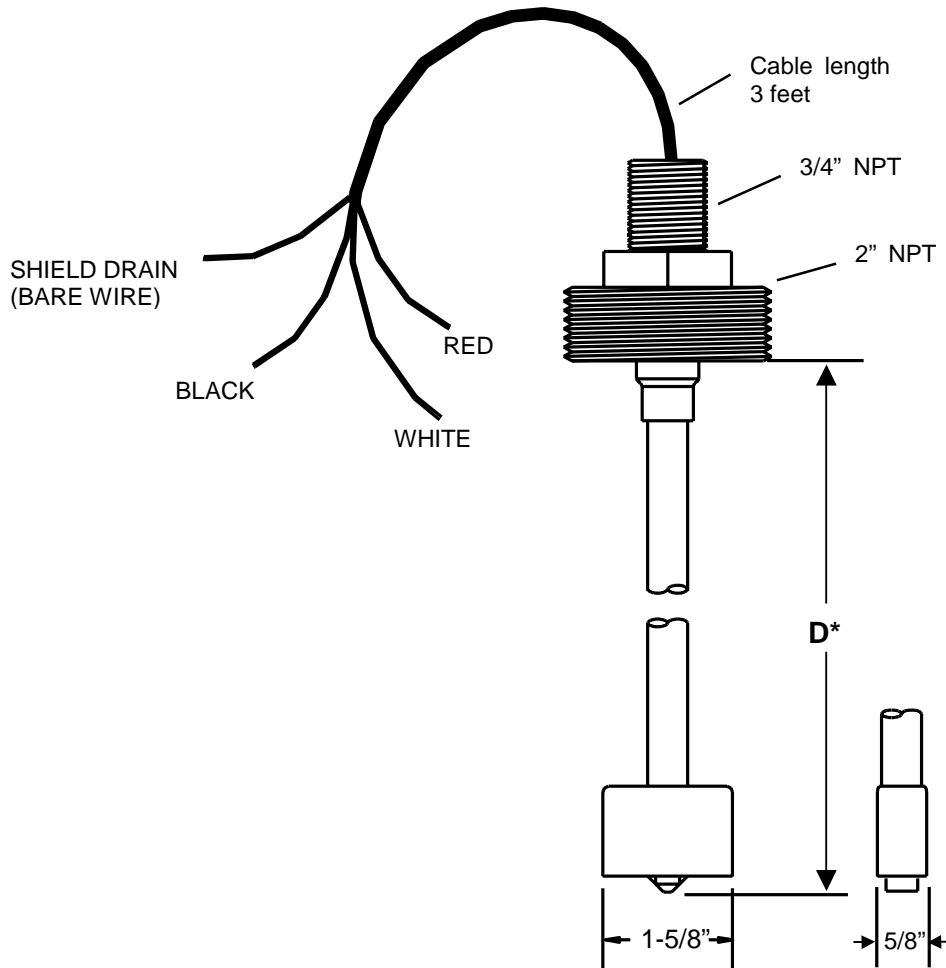

SPECIFICATIONS

U.L. LISTED 5L04

Intrinsically safe Class I, Group D Hazardous Locations when connected in accordance with Control Drawing nos. L1, L2, L3, L4, L6, L9

OPERATING TEMPERATURE

-40 TO +140 F

POWER

2 VDC @ 13 mA

WEIGHT

2 pounds

PRINCIPLES OF OPERATION

LIQUIDS (ex: fuel, water) – Photo Optic
 DRY CONDITION – Normally closed light beam
 ALARM CONDITION – Opens (refracts) normally closed light beam

SENSOR CABLE

Shielded 22 AWG UL-E118830 CM
 Maximum length 2000 feet

RESPONSE TIME

Immediate

Non-product distinguishing Fiberglass tank dry interstitial sensor

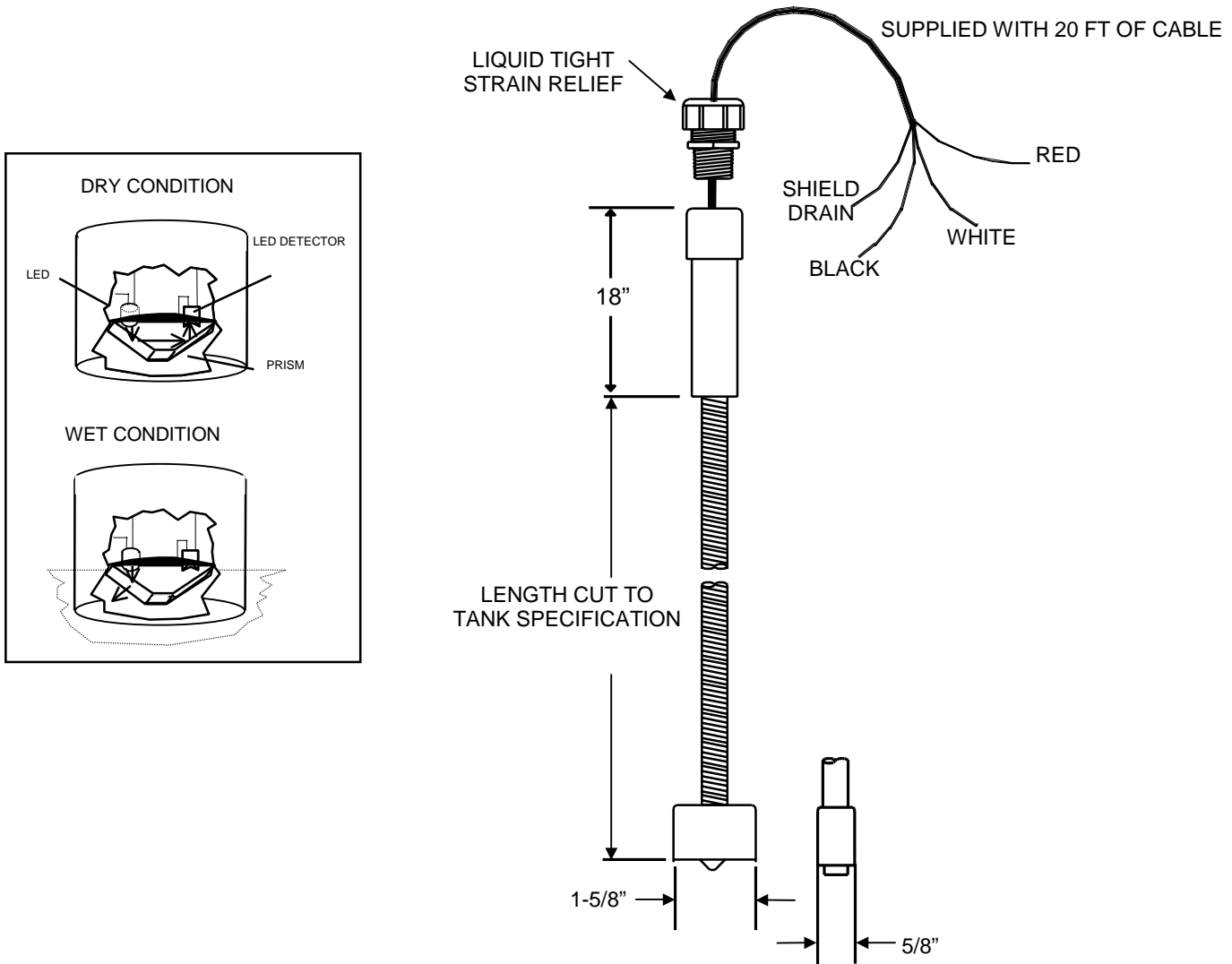

SPECIFICATIONS

OPERATING TEMPERATURE

-40 TO +140 F

POWER

2 VDC @ 13 mA

WEIGHT

2 pounds

PRINCIPLES OF OPERATION

LIQUIDS (ex: fuel, water) – Photo Optic
 DRY CONDITION – Normally closed light beam
 ALARM CONDITION – Opens (refracts) normally closed light beam

SENSOR CABLE

Shielded 22 AWG UL-E118830 CM
 Maximum length 2000 feet

RESPONSE TIME

Immediate

RA-Series Remote High Level Alarm

RA-1

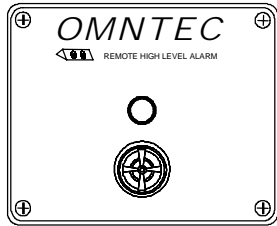

RA-2

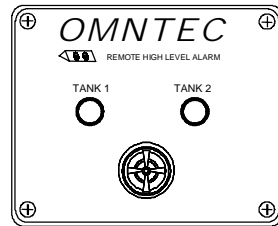

RA-3

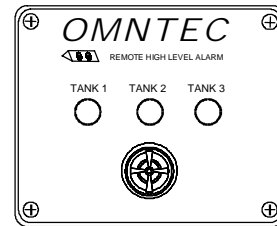

RA-4

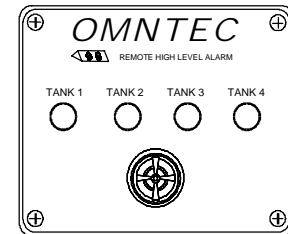

INTERNAL WIRING COLOR CODE

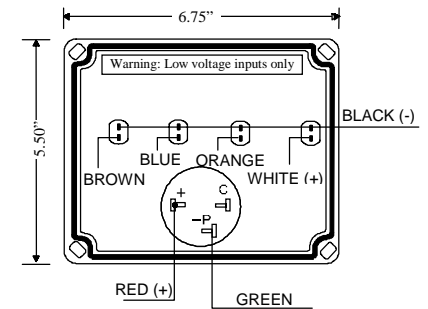
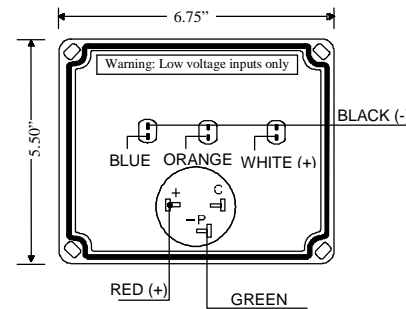
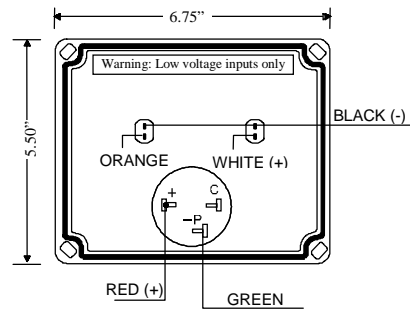
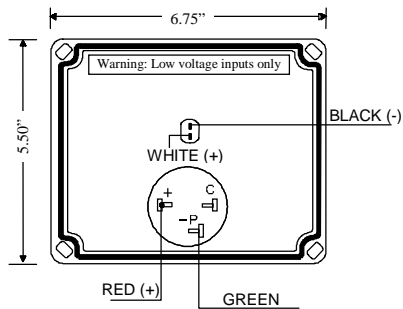

SPECIFICATIONS	
Audible Alarm	95 dB pulsing horn
Red Light	Liquid-high-level alarm
Response Time	Immediate
Power Input	12VDC @200mA maximum from controller
Wire	22 AWG minimum
Weight	1 lb.

SIDE VIEW

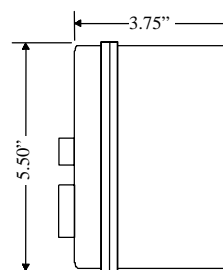

MOUNTING DIMENSIONS

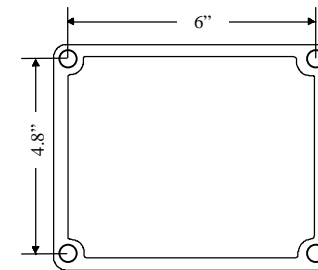

Note:
It is recommended that knockouts be placed in the bottom of the enclosure

OMNTEC LU-SERIES SYSTEM OPERATION AND TEST INSTRUCTIONS

1. On the front panel the Green "SYSTEM DETECTING" light should be on indicating that system is up and running. Note: if all red lights are on the horn will not sound when test button is pressed.

2. If sensors are not in alarm, all Red lights should be off
- Optical sensors are solid state and use a normally closed light loop in a prism for sensing. When liquid is present at sensor, the normally closed loop of light is open, thus sending an alarm signal back to the alarm panel. The panel responds by turning on the appropriate light and sounding an audible alarm

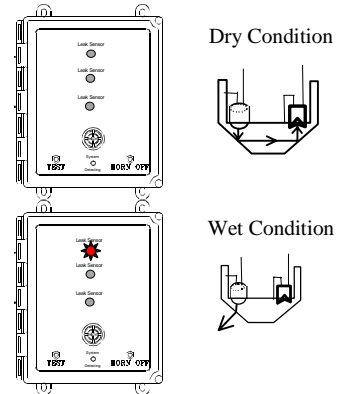

3. Since system sensors are solid state and work with normally closed loop of light, sensors can be tested as follows:

- Hit the test button on alarm panel and observe panel lights
- If all lights illuminate and audible alarm sounds, system test is complete
- When test button is hit a signal is sent to sensor to turn its light off. What this does is put the sensor into an alarm condition
- The sensor then responds as explained in part (2)

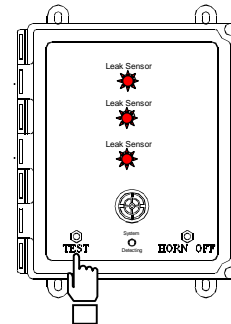

4. System should be tested on a weekly basis

5. Every alarm, malfunction and test result should be recorded in a dated signed log

Manufactured by:

Installed by:



OMNTEC Mfg., Inc.
1993 Pond Rd.
Ronkonkoma, New York 11779
Phone 631-981-2001 Fax 631-981-2007

LU-Series TROUBLESHOOTING PROCEDURES

FOR LU-SERIES CONTROLLERS WHEN USED WITH ELECTRO-OPTIC SENSORS

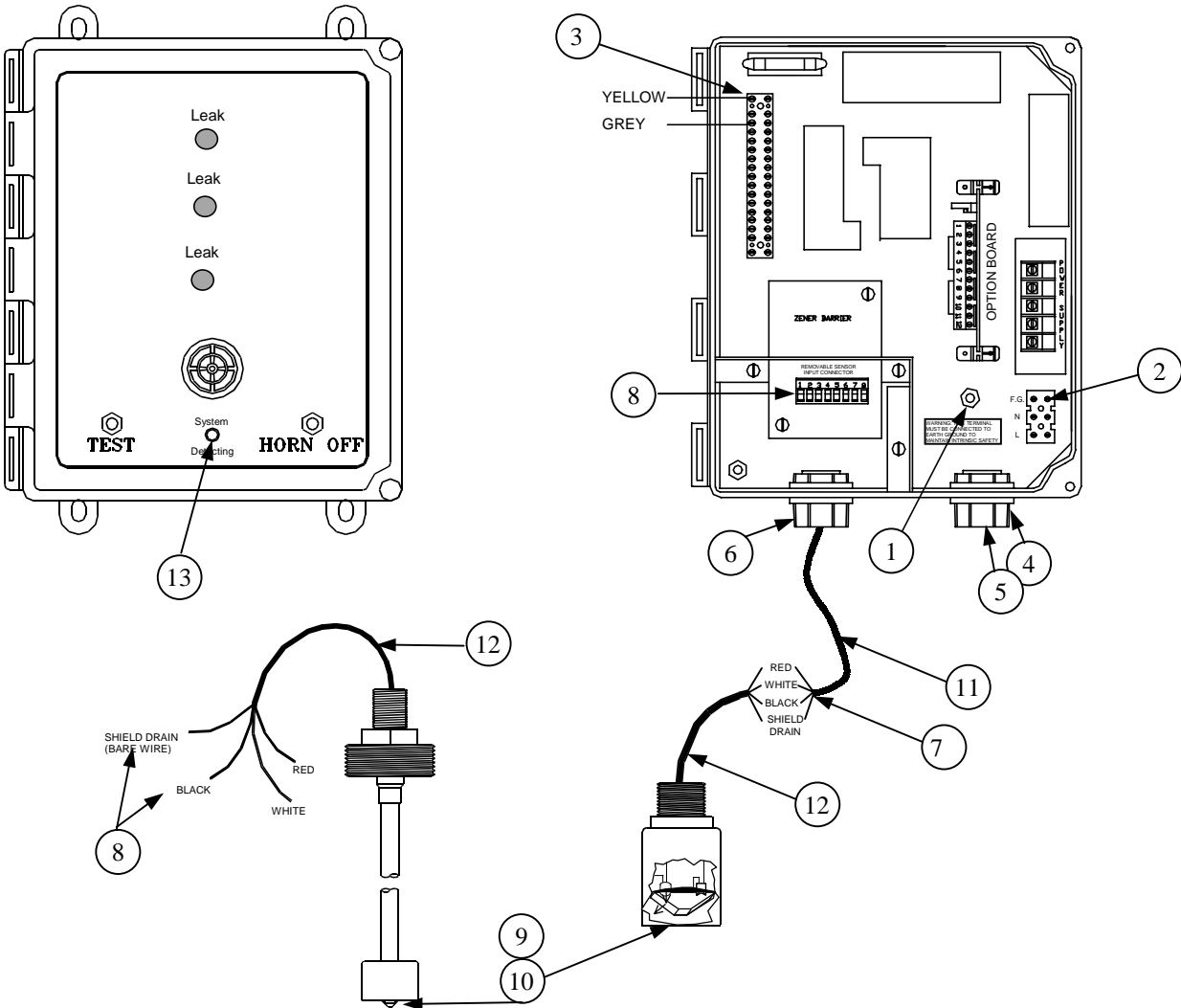

Be sure the following criteria are met before proceeding:

1. Controllers have there own separate isolated Earth Ground
2. Controllers have there own separate isolated Field Ground
3. The Controller should have 13.8 VDC on the output of the power supply (Across the yellow-positive and gray-negative wires) (adjusted at factory)
4. 120VAC wires are in there own separate isolated conduit
5. Remote Annunciator wires are in there own separated isolated low voltage conduit
6. Sensor wires are in there own separate isolated conduit
7. Sensor shield drain wire is not connected to black wire at sensor splice
8. Black & shield drain are connected to ground at removable input connector
9. Sensor head (prism) is not exposed to any light
10. Sensors are free of dirt and debris
11. Sensor extension cables are minimum 3 conductor #22 AWG shielded with drain wire
12. Sensors wires do not exceed 2000 ft.
13. The "System Detecting Light" should be illuminated

Troubleshooting Procedures

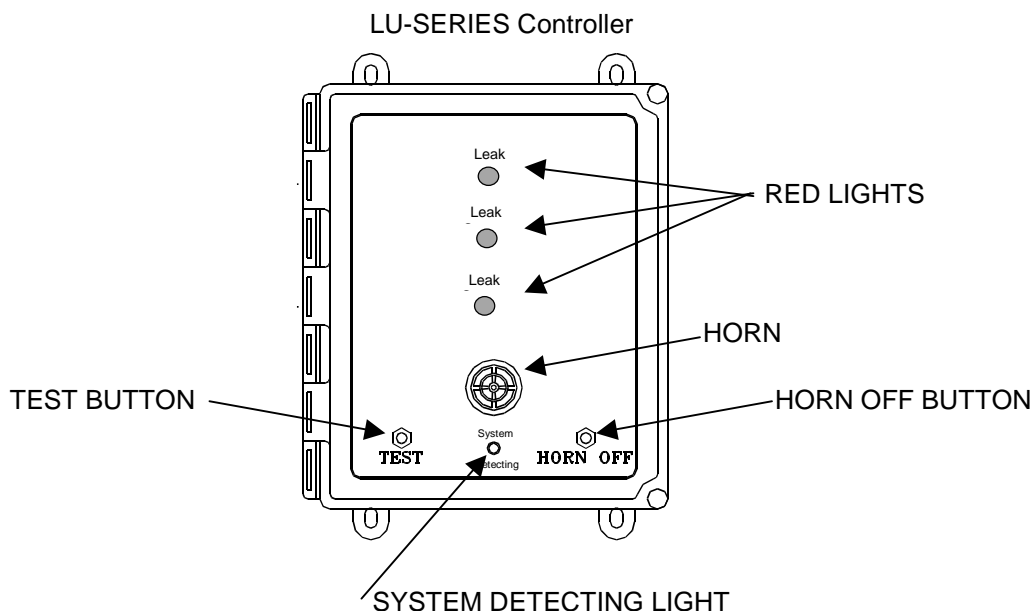

SYMPTOM	TROUBLESHOOTING PROCEDURE	RESULT
"Red Light" does not come on when test button is pressed.	1) Unplug sensors "Removable input connector" at controller. Does the "red Light" illuminate?	(YES) controller is functioning. Proceed to step 2. (NO) controller is not functioning (consult factory).
	2) Check wiring at removable input connector. Concentrate on white, black and shield wire inputs from sensors, making sure no shorts are present. Re-plug connector and press test button. Does the "Red Light" illuminate?	(YES) system is functioning properly. (NO) Proceed to step 3.
	3) Check splice at sensor for moisture or mis-wire (concentrating on white and black wires from sensor). Correct problem and press test button. Does the "Red Light" illuminate?	(YES) problem are in the wire connections at splice (NO) sensor is not functioning properly. Proceed to step 4.
	4) Remove sensor from installation, connect at controller, shroud from light and press test button. Does the "Red Light" illuminate?	(YES) problem in wire run to sensor. System is functioning properly. (NO) The sensor failed (consult factory)

SYMPTOM	TROUBLESHOOTING PROCEDURE	RESULT
"Red Light" remains on.	1) Check if sensor is actually in alarm (submerged)	(YES) correct alarm condition. (NO) proceed to step 2.
	2) Check wiring at removable input connector concentrating on red, white, black and shield wire inputs from sensors. Make sure no open circuits are present. Re-plug the connector and press test. Does the "Red Light" stay on?	(YES) proceed to step 3. (NO) System is functioning properly. Problem was in the wire or connections.
	3) Disconnect sensor wires from removable sensor input connector. Connect a jumper from sensors white wire input to sensors black wire input. Make sure all sensor wiring is disconnected. Does the "Red Light" stay on?	(YES) Controller is not functioning properly (consult factory) (NO) Controller is functioning properly. Proceed to step 4.
	4) Disconnect sensor wires from removable sensor input connector. Check voltage at red sensor wire input to black sensor wire input, and, from white sensor wire input to black sensor wire input. Is red to black reading approximately 8 volts DC and white to black reading 1.1 volts DC?	(YES) Controller is functioning properly. Proceed to step 5. (NO) Controller is not functioning properly (consult factory)
	5) Check splice at sensor for moisture or mis-wire. Correct problem. Does the "Red Light" stay on?	(YES) proceed to step 6. (NO) If light goes off before pressing test button and goes on after pressing test button System is functioning properly. Problem was in the connection or wire.
	6) Connect sensor directly to controller. Make sure sensor head is not exposed to light during test. Does the "Red Light" stay on?	(YES) Sensor is not functioning properly (consult factory) (NO) Problem is in the wire or connections.
Horn does not sound on controller when the "TEST" button is pressed.	1) Are any "Red Lights" illuminated on controller?	(YES) Make sure at least one input is not in alarm state. Then proceed to step 2. (NO) proceed to step 2.
	2) Shut down system for 30 seconds. Turn system back on. Does horn sound when hitting the "TEST" button?	(YES) Controller is functioning properly. (NO) Controller is not functioning properly. Proceed to step 3.
	3) While holding the "TEST" button down put a voltmeter on the positive and negative on the back of the horn. Do you get 13.8 volts +/- 1?	(YES) Your horn does not work. Replace horn. (NO) Your horn board is not working (consult factory)

WARRANTY

The seller OMNTEC Mfg., Inc. warrants to buyer, for one year: That all components meet specifications herein. All components are free of defects when properly installed, and maintained by user. The sellers sole obligation is to repair or replace parts found to be defective, or non-conforming after evaluation by factory. The liability of the seller shall not exceed the price paid for the components found to be defective. The above warranty is exclusive of all other warranties whether implied or expressed. Seller assumes no obligation for special or, indirect damages incurred by user.