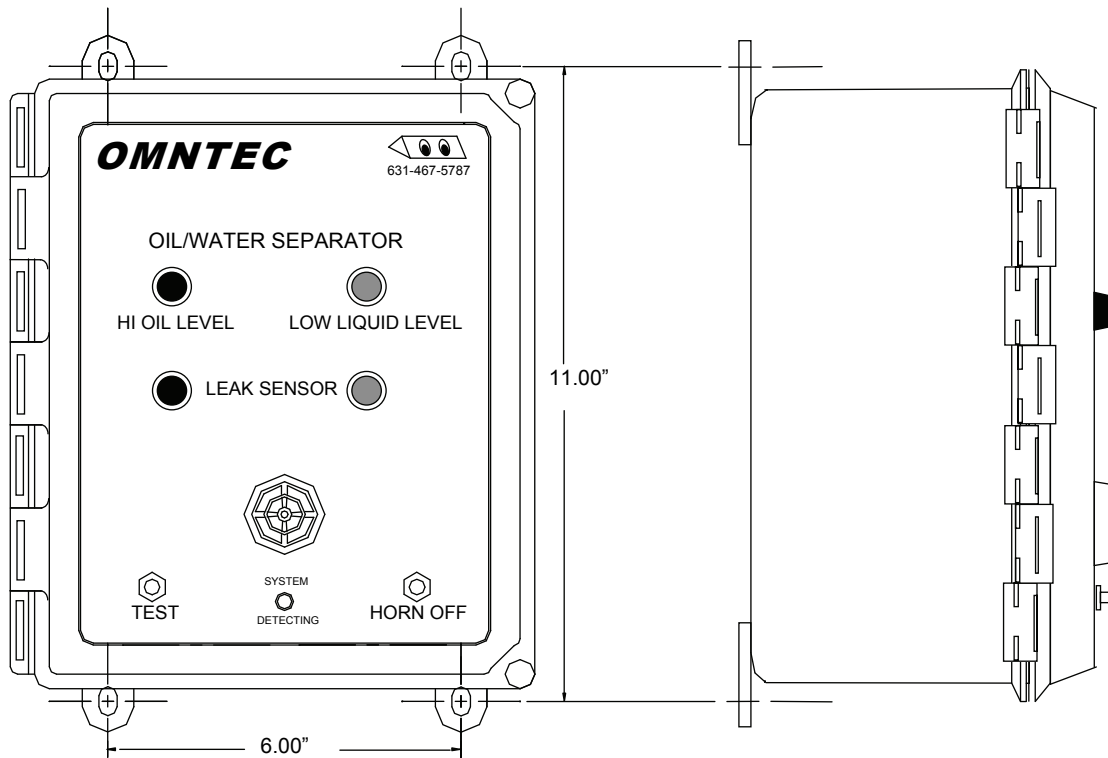

OIL WATER SEPARATOR ALARM CONSOLE

**SPECIFICATIONS****POWER INPUT**

85-125 VAC, 47-440 Hz
16 Watts maximum

POWER TO SENSORS

13.80 VDC @ 13 ma

RELAY OUTPUT

SPST normally open dry contacts 1.25 AMPS, 120
AC/DC switches when an alarm condition occurs

WEIGHT

6 LBS.

ENCLOSURE

NEMA 4X

DIMENSIONS

(W) 9" x (H) 10.5"

SENSOR CABLE

Shielded 22 AWG UL-E118830 CM
Maximum length 2000 feet

ENCLOSURE

NEMA 4X

OPERATING TEMPERATURE

-40° to 140° F

UL LISTED

Intrinsically safe circuits for use in class I
group D hazardous locations when connected
in accordance with control drawing LU2OW
LABELS – provided with controller

AUDIO/VISUAL CONSOLE

AUDIBLE ALARM - 95 dB pulsing horn with no timeout

HI OIL LIGHT -Indicates oil has accumulated below the hi oil
interface float

LOW LIQUID LEVEL LIGHT - indicates the liquid level has
dropped below the liquid level float

RED LEAK LIGHT – Indicates high alarm for L-R-1, hi oil level
for OWP-2, or product alarm for PD-series sensor

AMBER LEAK LIGHT – Indicates low alarm for L-R-1, low
liquid level for OWP-2, or water alarm for PD-series sensor

TEST BUTTON- When pressed will actually test system
electronics from control panel to sensors

GREEN LIGHT- indicates the power is on

HORN OFF BUTTON - Silences the audible alarm when
pressed

SENSORS

OWP-2 Two point pump-out float sensor
PD-series Product distinguishing liquid optic sensor
L-R-1 Reservoir sensor

ACCESSORIES

RA-1 audio/visual remote annunciator
RLY-RA Relay (consult factory)
RA-1-NYS Remote annunciator with strobe (consult factory)

ELP21LU3-OWPR

CONTROLLER CONNECTION DIAGRAM

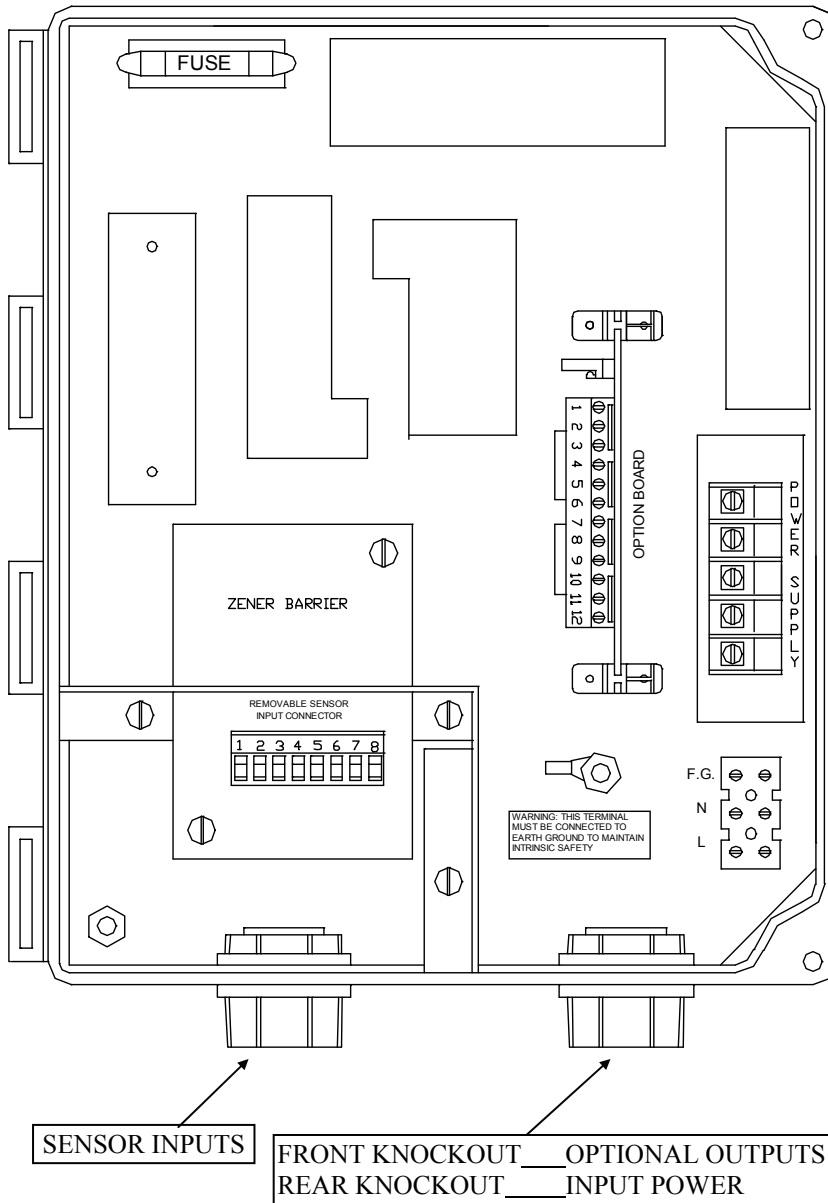

COLOR CODE

CABLE FROM SENSOR TO REMOVABLE SENSOR INPUT CONNECTOR

1	RED	HI OIL LEVEL	SENSOR #1
2	WHITE	LOW LIQUID	OWP-2
3	UNUSED		
4	RED	LEAK SENSOR	SENSOR #2
5	WHITE		
6	GREEN		
7	BLACK	GROUND	FROM ALL SENSORS
8	SHIELD DRAIN	SHIELD	

WIRES TO OPTION BOARD

WIRES FROM LOW VOLTAGE REMOTE

1	GREEN	-HORN	
2	RED	+HORN	
3	BLACK	GROUND	
4	WHITE	HI OIL LEVEL	SENSOR #1
5	ORANGE	LOW LIQUID	SENSOR #1
6	BLUE	LEAK	SENSOR #2

WIRES FROM RELAY OUTPUTS

7	COMMON	LEAK
8	NORMALLY OPEN	SENSOR #2
9	COMMON	LOW LIQUID LEVEL
10	NORMALLY OPEN	SENSOR #1
11	COMMON	HI OIL LEVEL
12	NORMALLY OPEN	SENSOR #1

120VAC

WIRES TO POWER SUPPLY

F.G.	FIELD GROUND
L	LINE
N	NEUTRAL

NOTE: To maintain proper shielding, BLACK sensor wires and SHIELD DRAINS should **not** be connected together at sensors.

ELP21LU3-OWPR SYSTEM CONTROL DRAWING

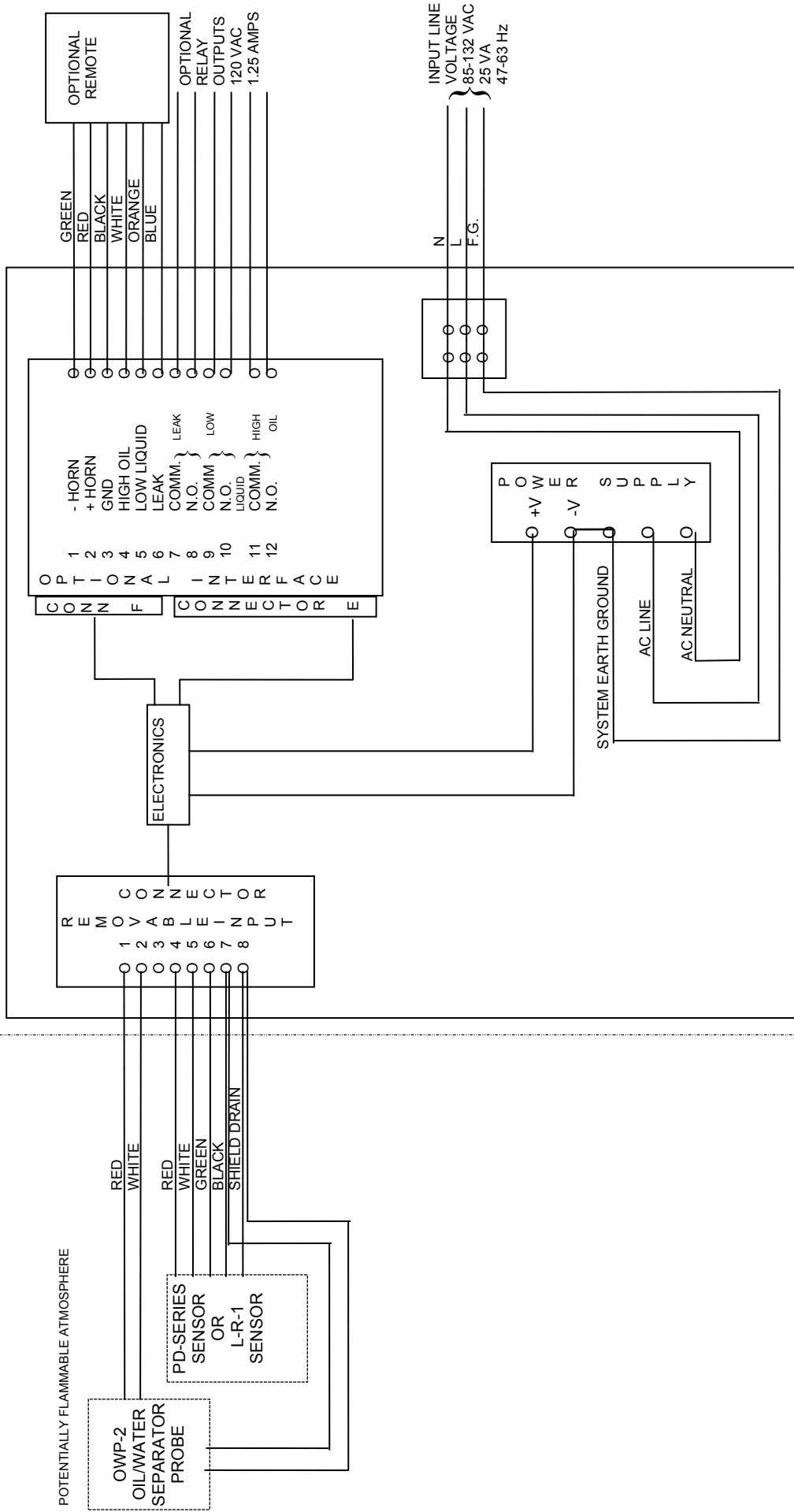

Control drawing no. LU2OWP

NOTES ON PROBES

1. THE INTRINSICALLY SAFE FIELD WIRING SHALL BE INSTALLED IN ACCORDANCE WITH ARTICLE 504 IN THE NATIONAL ELECTRICAL CODE ANS/NFPA 70
2. ALL PROBES ARE ELECTRICALLY IDENTICAL AND MAY BE INTERCHANGED ALLOWING SYSTEM FLEXIBILITY
3. PROBE TO CONTROL UNIT CABLE WILL BE TWO PAIR OF #22 AWG WITH SHIELD AND DRAIN PVC JACKETED UL-118830 CM. CABLE LENGTH WILL BE LIMITED TO 2000 FEET MAXIMUM

NOTES ON CONTROL EQUIPMENT

1. ALL WIRING MUST MEET LOCAL AND NATIONAL ELECTRICAL CODES
2. SYSTEM EARTH GROUND MUST BE CONNECTED TO TERMINAL F.G. TO INSURE INTRINSIC SAFETY AND MUST BE LESS THEN 1Ω WITH RESPECT TO EARTH GROUND
3. OPTIONAL REMOTE REQUIRES #22 AWG LOW VOLTAGE COMMUNICATION CABLE MINIMUM

NON-HAZARDOUS AREA

OMNTEC Mfg., Inc.

1993 Pond Rd., Ronkonkoma, New York 11779

Phone 631-981-2001

Fax 631-981-2007

3 of 13

www.OMNTEC.com

lu3-owpr.doc 11/22/13

RA-Series Remote High Level Alarm

RA-1



RA-2

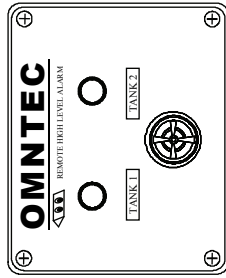

RA-3

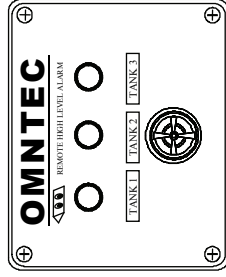

RA-4

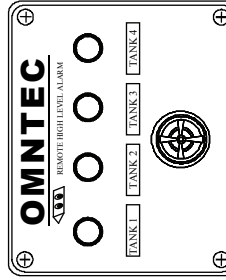

Internal Wiring Color Code

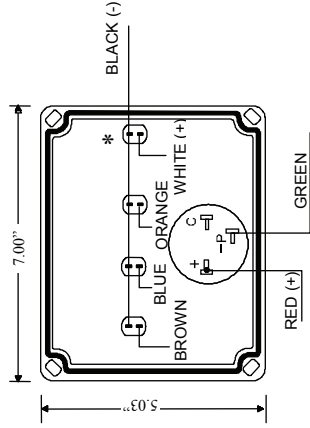
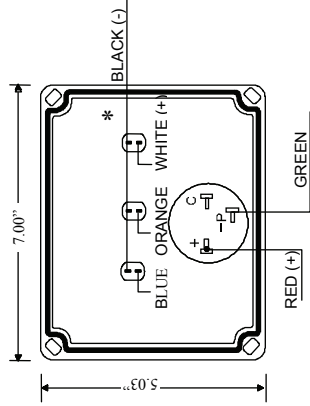
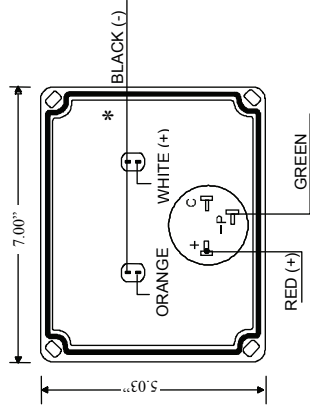
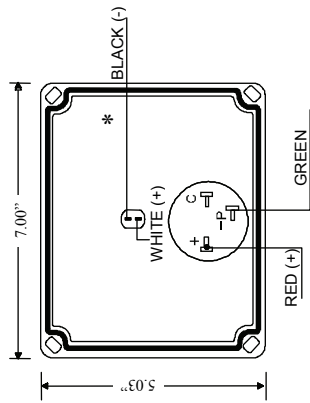

* **WARNING LABEL PLACED HERE:** Warning: Low voltage inputs only

SPECIFICATIONS	
Audible Alarm	95 dB pulsing horn
Red Light	Liquid-high-level alarm
Response Time	Immediate
Power Input	12VDC @200mA maximum from controller
Wire	22 AWG minimum
Weight	1 lb.

SIDE VIEW

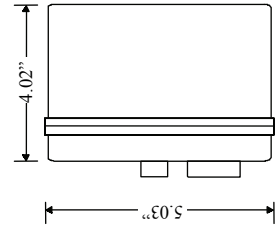

MOUNTING DIMENSIONS

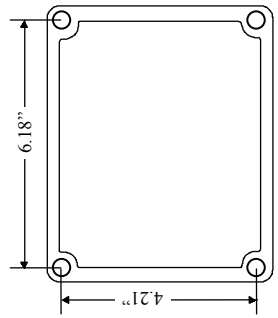

Note: It is recommended that knockouts be placed in the bottom of the enclosure

OWP-2 OIL WATER SEPARATOR

TYPICAL MANWAY EXTENSION BRACKET INSTALLATION

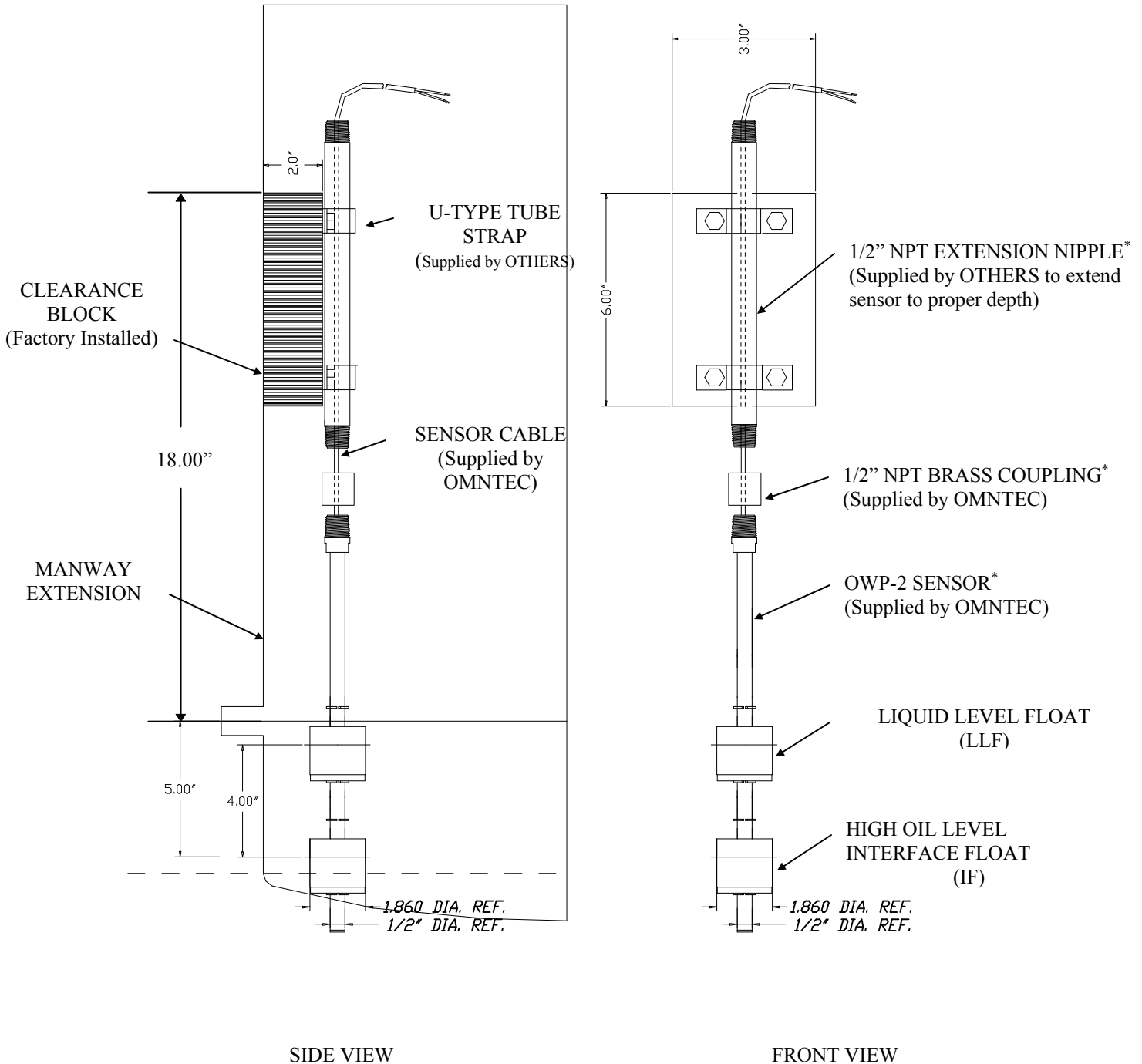

* **WARNING-** It is the installer's responsibility to select a thread sealant that is compatible with the product being stored and that all NPT fittings are fastened properly to assure liquid tight seal for proper sensor operation.

OWP-2 OIL WATER SEPARATOR

TYPICAL MANWAY EXTENSION BRACKET INSTALLATION

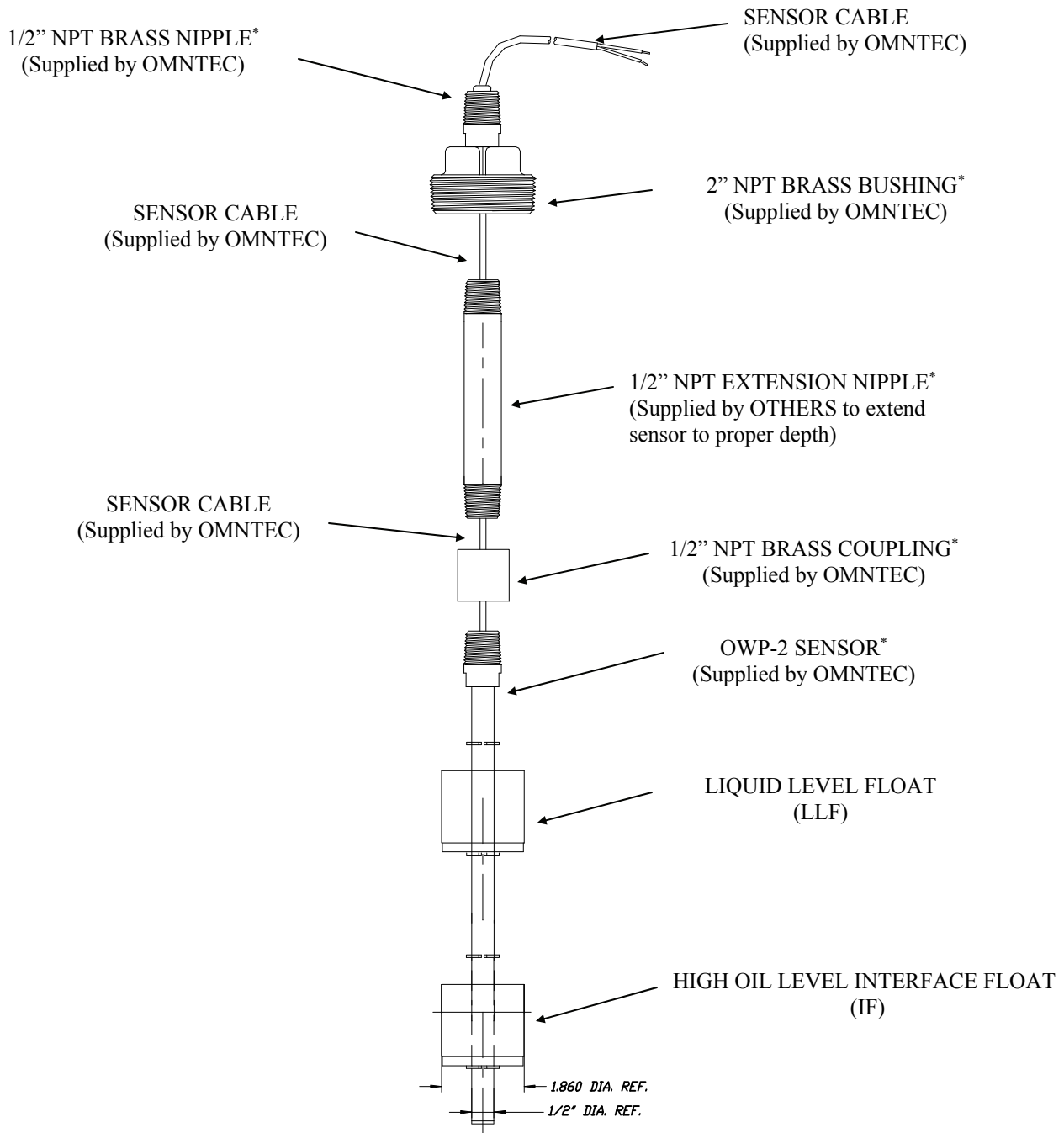

* **WARNING-** It is the installer's responsibility to select a thread sealant that is compatible with the product being stored and that all NPT fittings are fastened properly to assure liquid tight seal for proper sensor operation.

Product distinguishing Optic Sensor

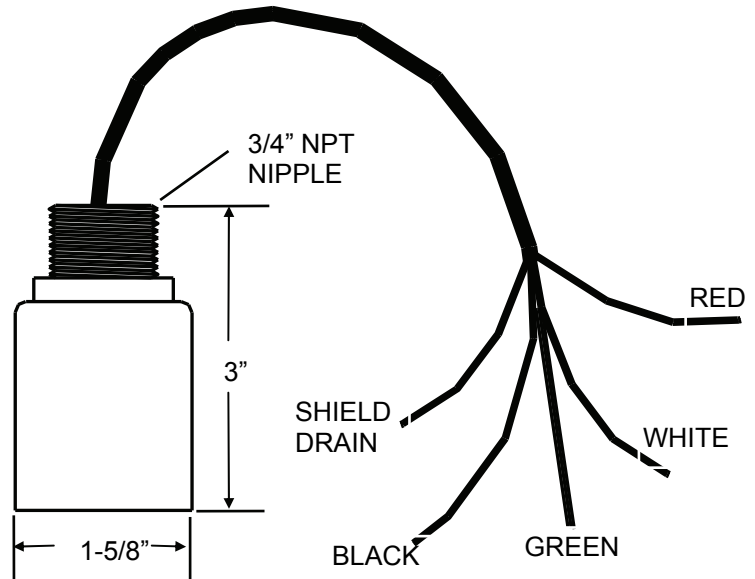
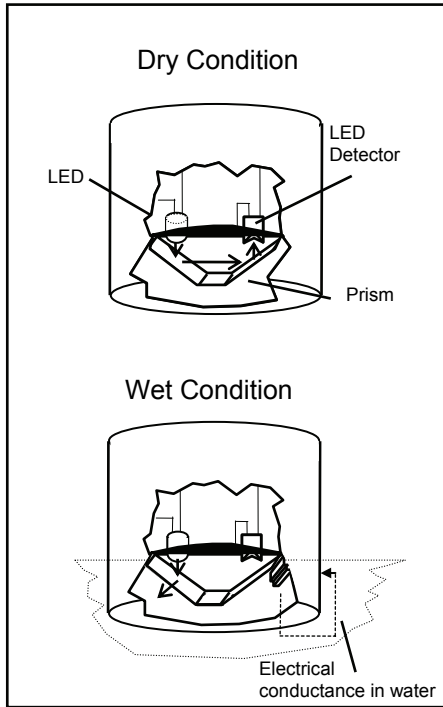

SPECIFICATIONS

Solid State (No moving parts)

U.L. LISTED 5L04

Intrinsically safe Class I, Group D Hazardous Locations when connected in accordance with Control Drawing nos. L1PD2, L2PD4, L3PD6

OPERATING TEMPERATURE

-40 TO +140 F

POWER

2 VDC @ 13 mA

WEIGHT

1/2 pound

PRINCIPLES OF OPERATION

WATER DETECTION - conductance
 NON-POLAR LIQUIDS (ex: fuel) – Photo Optic
 DRY CONDITION – Normally closed light beam
 ALARM CONDITION – Opens (refracts) normally closed light beam

SENSOR CABLE

Shielded 22 AWG UL-E118830 CM
 Maximum length 2000 feet

RESPONSE TIME

Immediate

Dry Interstitial Space Sensor For Use In Fiberglass Tanks - * denotes tank diameter

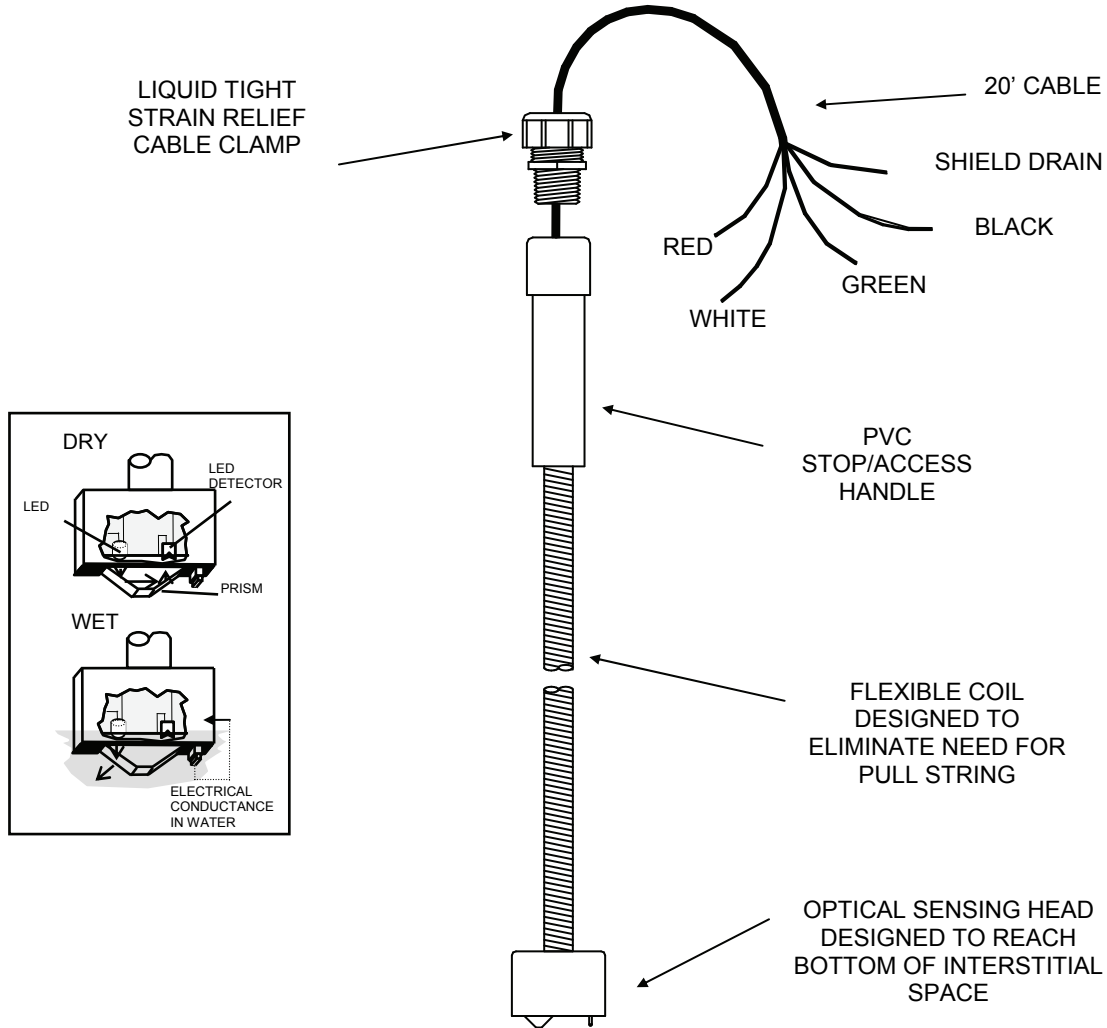

SPECIFICATIONS

Solid State (No moving parts)

U.L. LISTED 5L04

Intrinsically safe Class I, Group D Hazardous Locations when connected in accordance with Control Drawing nos. L1PD2, L2PD4, L3PD6

OPERATING TEMPERATURE

-40 TO +140 F

POWER

2 VDC @ 13 mA

WEIGHT

1/2 pound

PRINCIPLES OF OPERATION

WATER DETECTION - conductance
NON-POLAR LIQUIDS (ex: fuel) – Photo Optic
DRY CONDITION – Normally closed light beam
ALARM CONDITION – Opens (refracts) normally closed light beam

SENSOR CABLE

Shielded 22 AWG UL-E118830 CM
 Maximum length 2000 feet

RESPONSE TIME

Immediate

Product distinguishing Optic Sensor

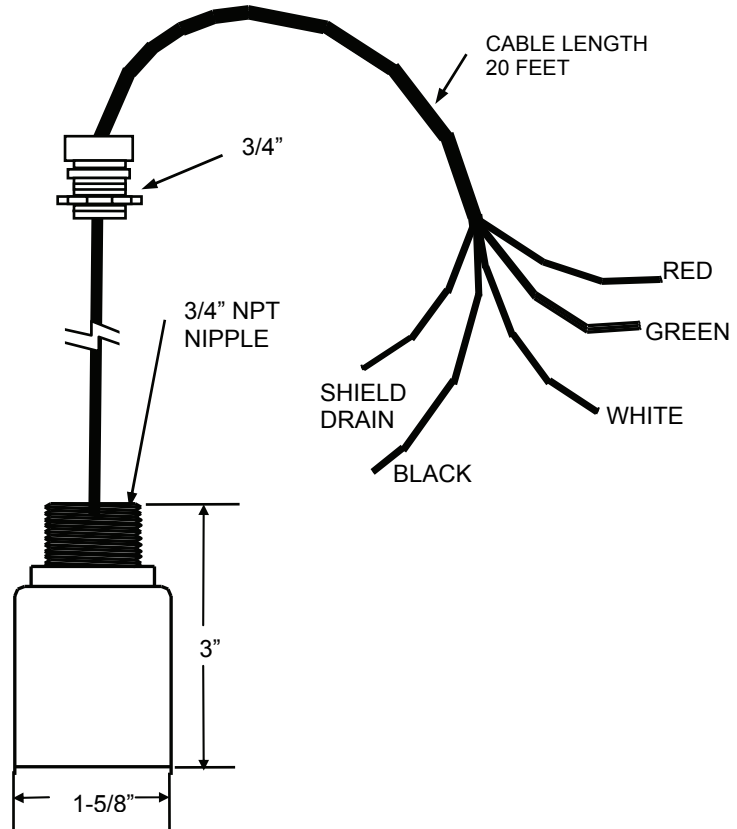
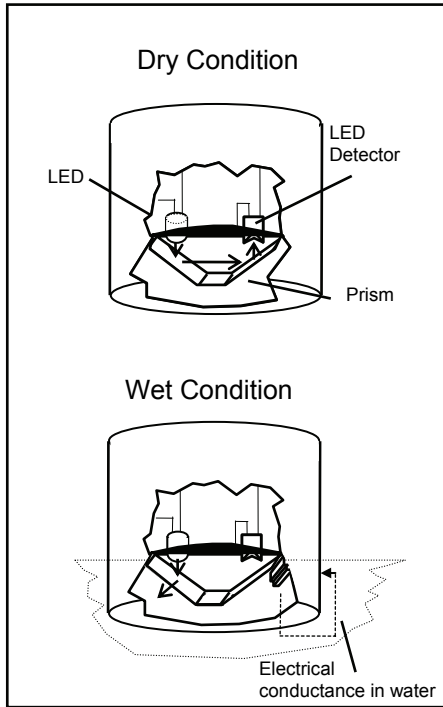

SPECIFICATIONS

Solid State (No moving parts)

U.L. LISTED 5L04

Intrinsically safe Class I, Group D Hazardous Locations when connected in accordance with Control Drawing nos. L1PD2, L2PD4, L3PD6

OPERATING TEMPERATURE

-40 TO +140 F

POWER

2 VDC @ 13 mA

WEIGHT

1/2 pound

PRINCIPLES OF OPERATION

WATER DETECTION - conductance
 NON-POLAR LIQUIDS (ex: fuel) – Photo Optic
 DRY CONDITION – Normally closed light beam
 ALARM CONDITION – Opens (refracts) normally closed light beam

SENSOR CABLE

Shielded 22 AWG UL-E118830 CM
 Maximum length 2000 feet

RESPONSE TIME

Immediate

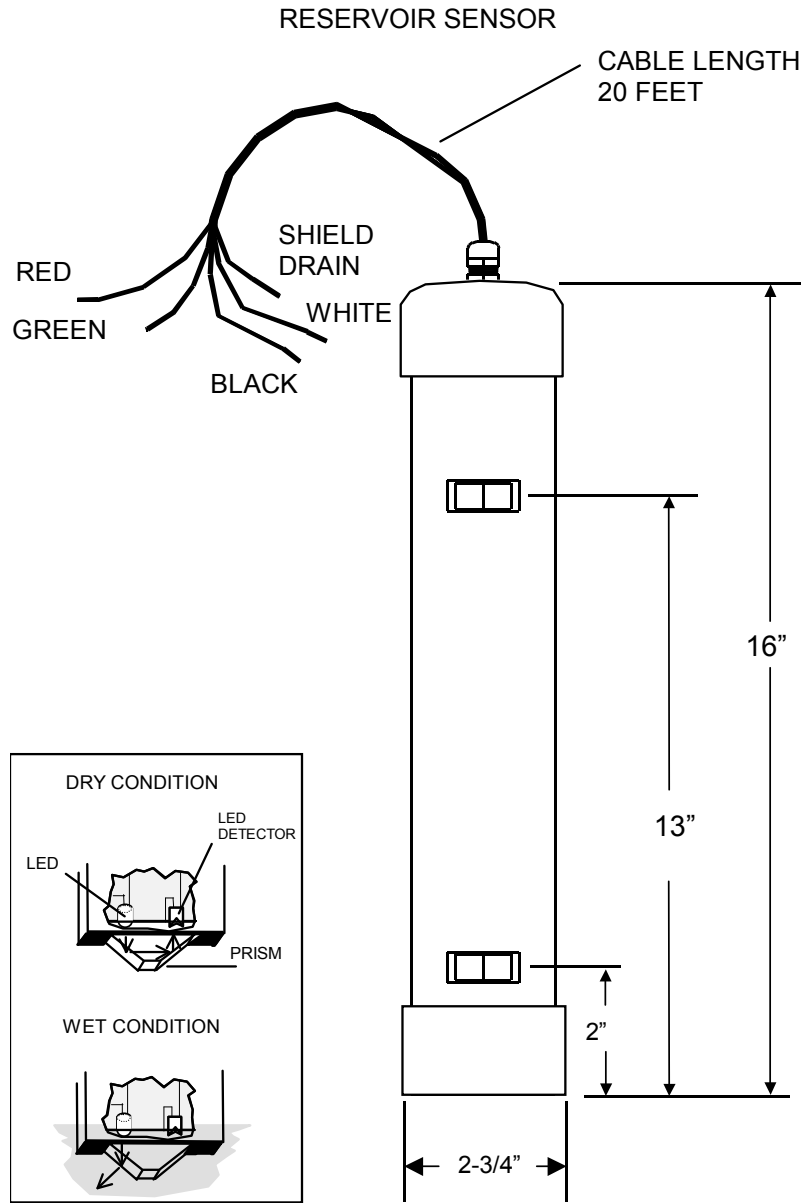

SPECIFICATIONS

SOLID STATE (NO MOVING PARTS)

<p>RESPONSE TIME IMMEDIATE</p>	<p>PROBE CABLE EC-4 OR BELDEN 9940 MAXIMUM LENGTH 2000 FEET</p>	<p>PRINCIPLES OF OPERATION NON POLAR LIQUIDS (FUEL OIL) - PHOTO OPTIC</p>
<p>POWER 2 VDC @ 13 mA</p>	<p>OPERATING TEMPERATURE -40° to 140° F</p> <p>WEIGHT 2 POUNDS</p>	<p>DRY CONDITION – HIGH LEVEL NORMALLY CLOSED LIGHT BEAM ALARM CONDITION – CLOSED BEAM OF LIGHT OPENS (REFRACTS) NORMAL CONDITION-LOW LEVEL NORMALLY OPEN LIGHT BEAM ALARM CONDITION – OPEN BEAM OF LIGHT CLOSES</p>

L-R-1

TYPICAL RESERVOIR SENSOR INSTALLATION

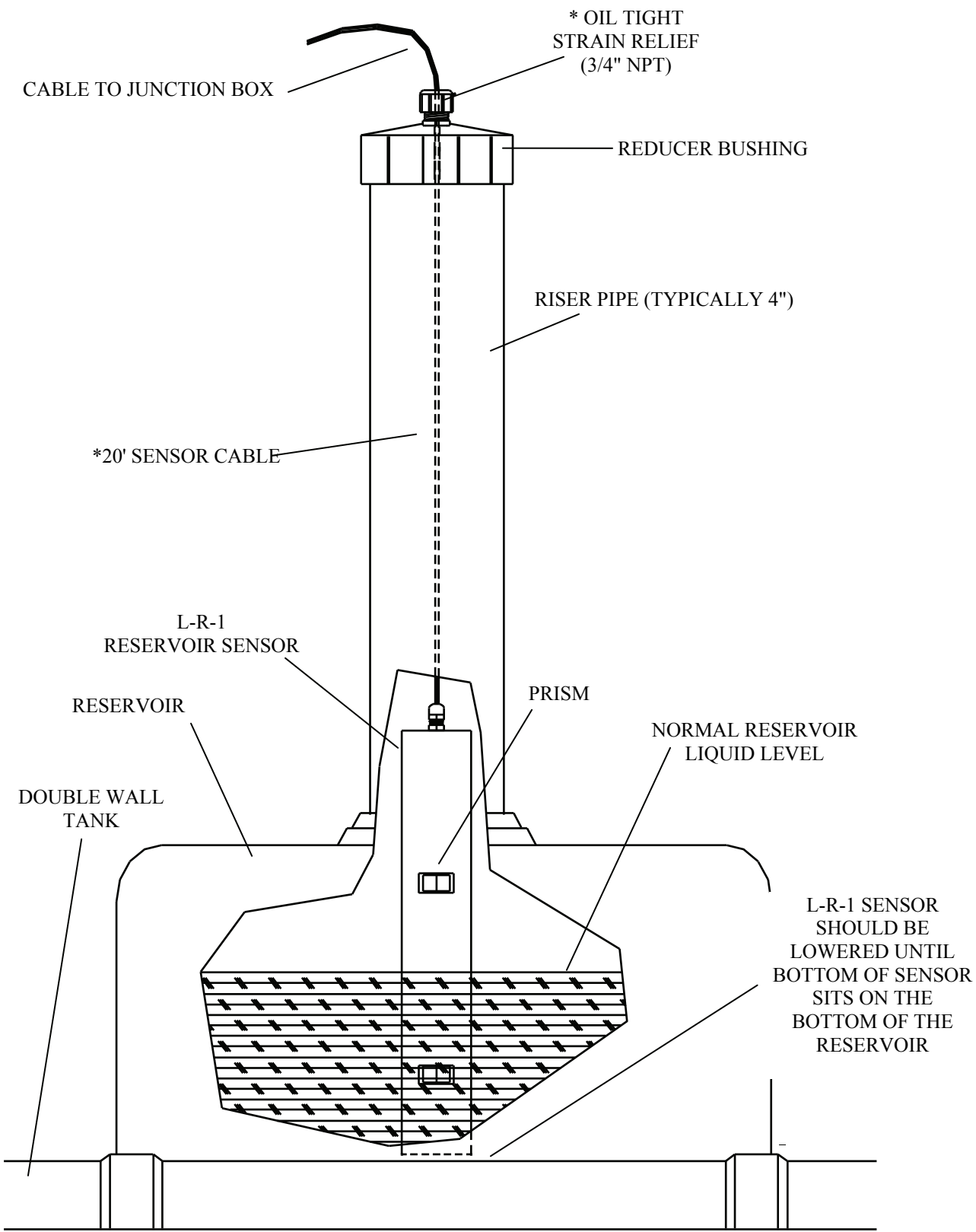

*SUPPLIED BY OMNTEC MFG., INC.

LOG SHEET

DATE	NAME	SYSTEM STATUS	SIGNATURE

WARRANTY

The seller OMNTEC Mfg., Inc. warrants to buyer, for one year: That all components meet specifications herein. All components are free of defects when properly installed, and maintained by user. The sellers sole obligation is to repair or replace parts found to be defective, or non-conforming after evaluation by factory. The liability of the seller shall not exceed the price paid for the components found to be defective. The above warranty is exclusive of all other warranties whether implied or expressed. Seller assumes no obligation for special or, indirect damages incurred by user.