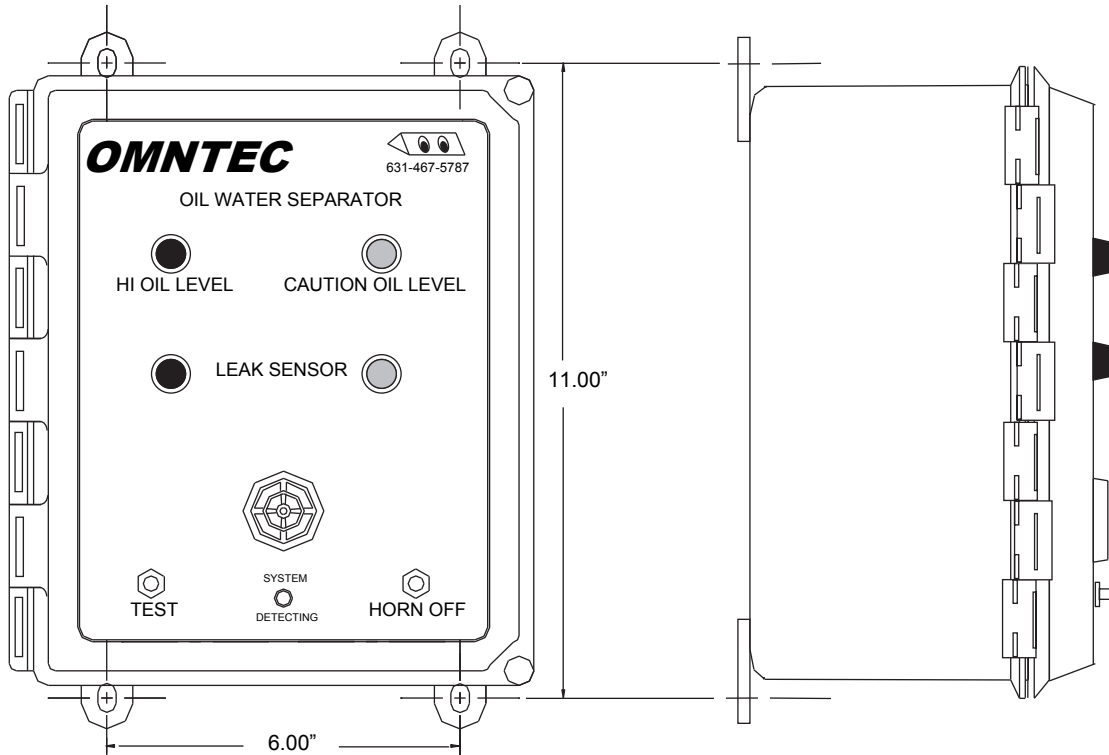

OMNTEC**LU3-OWIR****OIL WATER SEPARATOR ALARM CONSOLE****SPECIFICATIONS****POWER INPUT**

85-125 VAC, 47-440 Hz
16 Watts maximum

POWER TO SENSORS

13.80 VDC @ 13 ma maximum

RELAY OUTPUT

SPST normally open dry contacts 0.5 AMPS, 120
AC/DC switches when an alarm condition occurs

WEIGHT

6 LBS.

ENCLOSURE

NEMA 4X

DIMENSIONS

(W) 8.75" x (H) 10.5"

SENSOR CABLE

Shielded 22 AWG UL-E118830 CM
Maximum length 2000 feet

OPERATING TEMPERATURE

-40° to 140° F

UL LISTED

Intrinsically safe circuits for use in class I
group D hazardous locations when connected
in accordance with control drawing LU3OWIR

LABELS

Provided with controller

AUDIO/VISUAL CONSOLE

AUDIBLE ALARM - 95 dB pulsing horn with no timeout

CAUTION OIL LIGHT - Indicates oil has accumulated below
the caution oil interface float

HI OIL LIGHT - Indicates oil has accumulated below the hi oil
interface float or the tank liquid level is below the hi oil interface
float

RED LEAK LIGHT - Indicates hi alarm for L-R-1 or product
alarm for PD-series sensor

AMBER LEAK LIGHT - indicates low level alarm for L-R-1 or
water alarm for PD-series sensor

TEST BUTTON - When pressed will test system electronics

GREEN LIGHT - Indicates the power is on

HORN OFF BUTTON - Silences the audible alarm when
pressed

SENSORS

OWI-2 Two point oil/water interface float sensor

L-R-1 Reservoir sensor

PD-series Product distinguishing liquid optic sensor

ACCESSORIES

RA-1 Audio/visual remote annunciator

RLY-RA Relay (consult factory)

RA-1-NYS Remote annunciator with strobe (consult factory)

Dimensions for mounting and knockouts

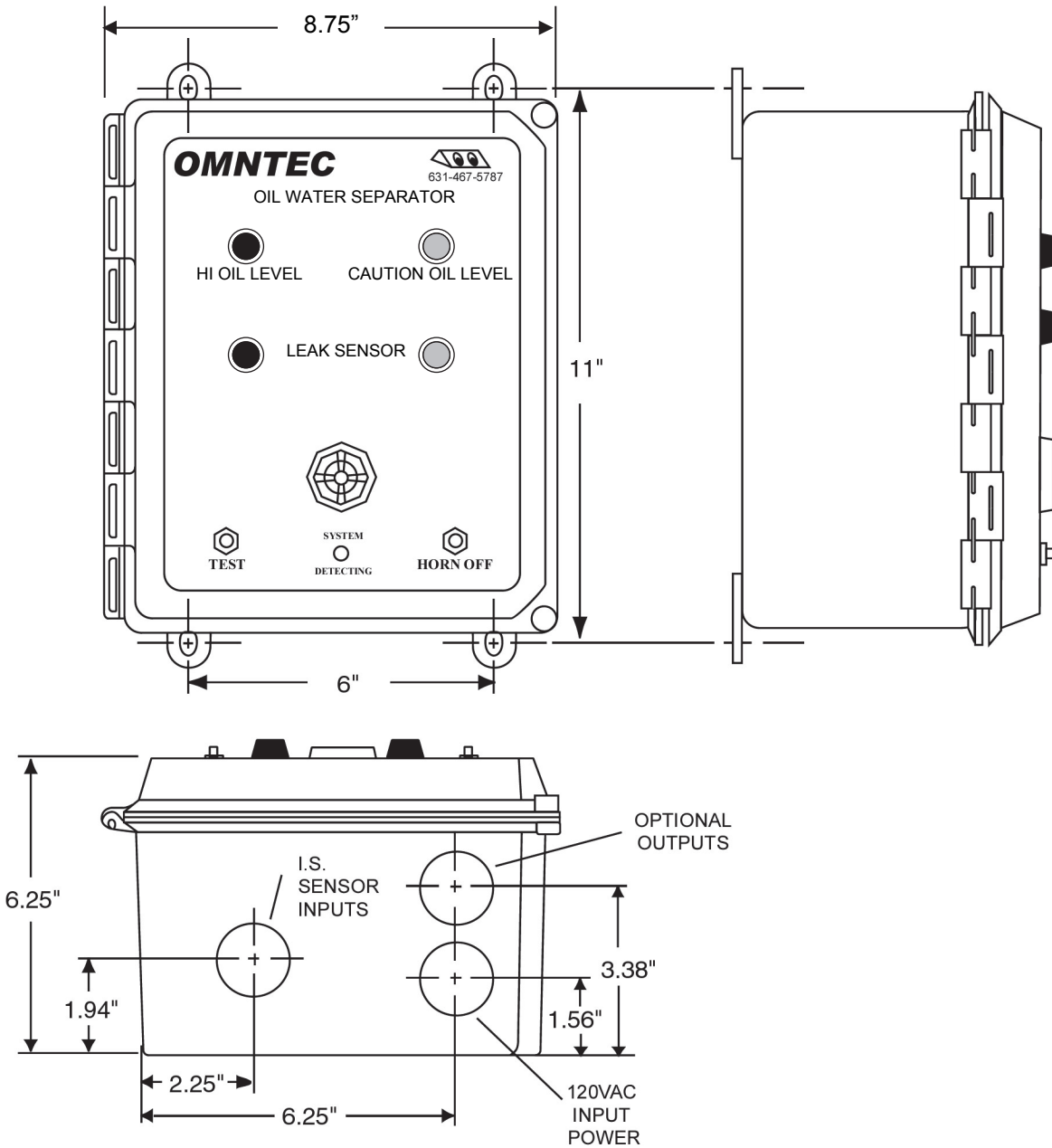

LU3-OWIR CONTROLLER CONNECTION DIAGRAM

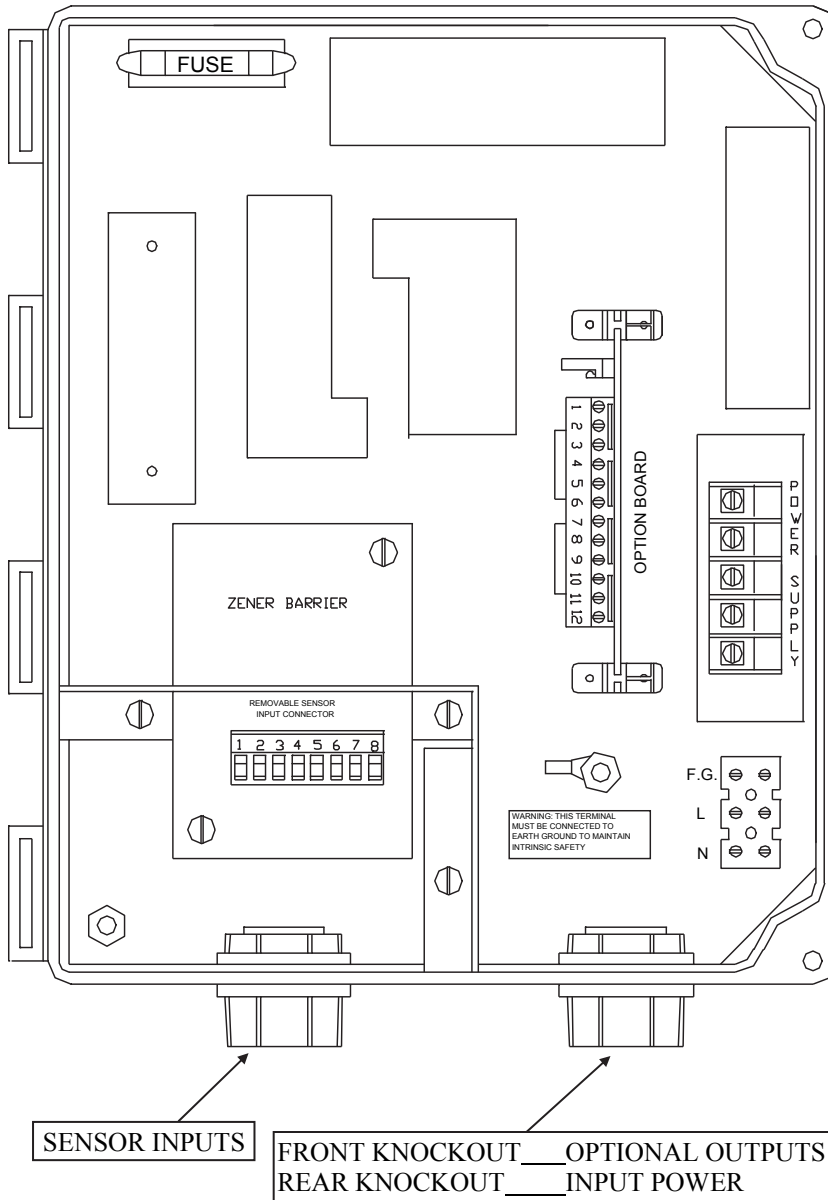

COLOR CODE

CABLES FROM SENSORS TO REMOVABLE SENSOR INPUT CONNECTORS

1	RED	HI OIL LEVEL	SENSOR #1
2	WHITE	CAUTION OIL LEVEL	OWI-2
3	UNUSED		
4	RED	LEAK DETECTION SENSOR #2	
5	WHITE		
6	GREEN		
7	BLACK	FROM SENSOR #1 & #2	
8	SHIELD DRAIN	FROM SENSOR #1 & #2	

WIRES TO OPTION BOARD

WIRES FROM RA-SERIES REMOTE

1	GREEN	-HORN
2	RED	+HORN
3	BLACK	GROUND
4	WHITE	HIGH OIL LEVEL
5	ORANGE	CAUTION OIL LEVEL
6	BLUE	LEAK DETECTION

WIRES FROM RELAY OUTPUTS

7	COMMON	LEAK DETECTION
8	NORMALLY OPEN	
9	COMMON	CAUTION OIL LEVEL
10	NORMALLY OPEN	
11	COMMON	HIGH OIL LEVEL
12	NORMALLY OPEN	

120VAC

WIRES TO POWER SUPPLY

F.G.	FIELD GROUND
L	LINE
N	NEUTRAL

NOTE: To maintain proper shielding, BLACK sensor wires and SHIELD DRAINS should **not** be connected together at sensors.

LU3-OWIR SYSTEM CONTROL DRAWING

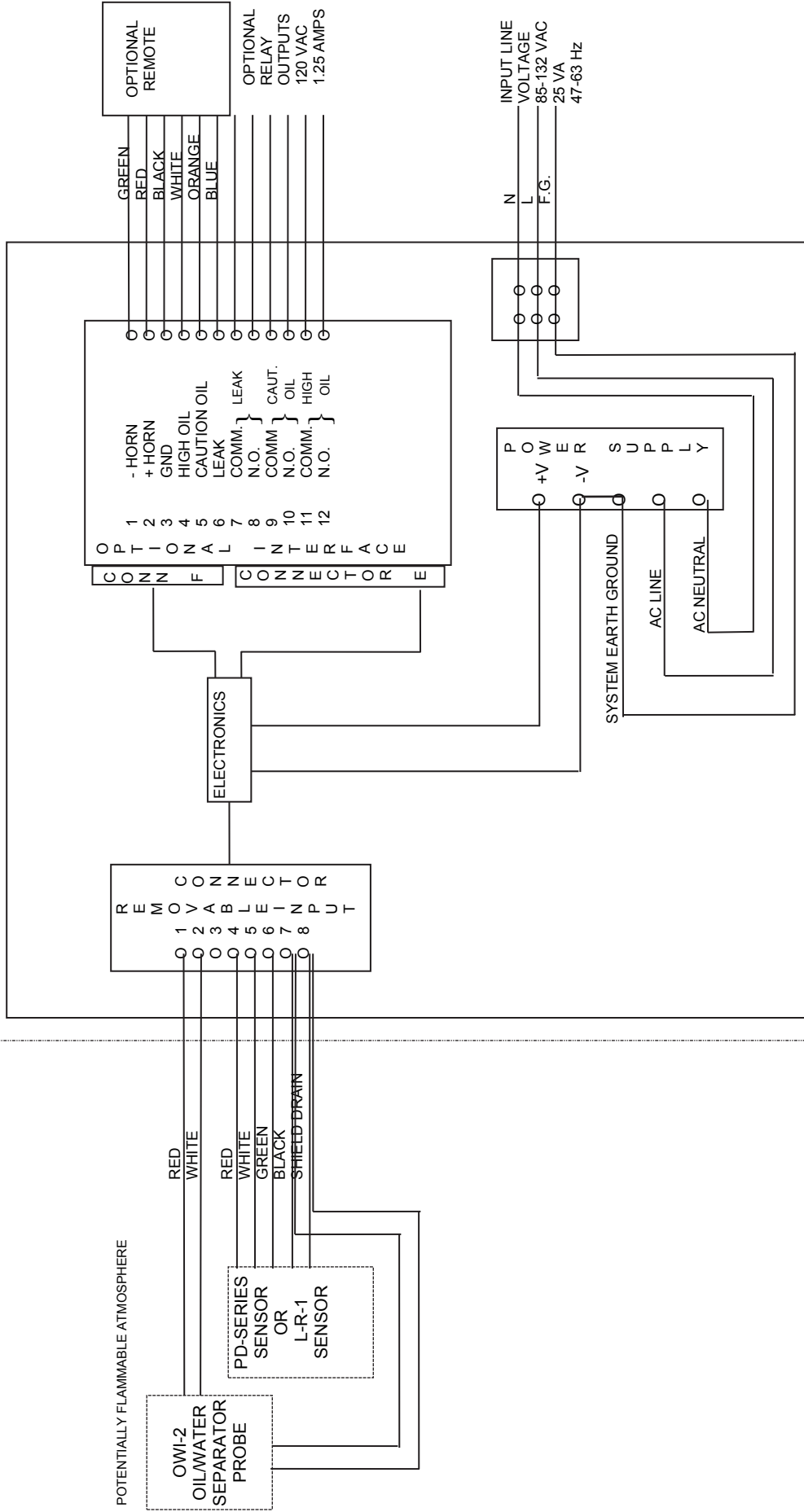

CLASS 1, GROUP D HAZARDOUS AREA

NOTES ON PROBES

1. THE INTRINSICALLY SAFE FIELD WIRING SHALL BE INSTALLED IN ACCORDANCE WITH ARTICLE 504 IN THE NATIONAL ELECTRICAL CODE ANSI/NFPA 70
2. ALL PROBES ARE ELECTRICALLY IDENTICAL AND MAY BE INTERCHANGED ALLOWING SYSTEM FLEXIBILITY
3. PROBE TO CONTROL UNIT CABLE WILL BE TWO PAIR OF #22 AWG WITH SHIELD AND DRAIN PVC JACKETED UL-118830 CM. CABLE LENGTH WILL BE LIMITED TO 2000 FEET MAXIMUM

NOTES ON CONTROL EQUIPMENT

1. ALL WIRING MUST MEET LOCAL AND NATIONAL ELECTRICAL CODES
2. SYSTEM EARTH GROUND MUST BE CONNECTED TO TERMINAL F.G. TO INSURE INTRINSIC SAFETY AND MUST BE LESS THEN 1Ω WITH RESPECT TO EARTH GROUND
3. OPTIONAL REMOTE REQUIRES #22 AWG LOW VOLTAGE COMMUNICATION CABLE MINIMUM

NON-HAZARDOUS AREA

RA-Series Remote High Level Alarm

RA-1

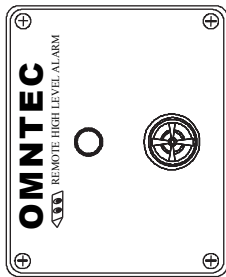

RA-2

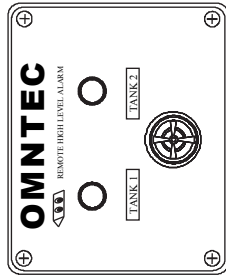

RA-3

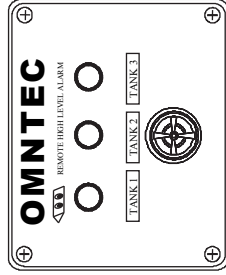

RA-4

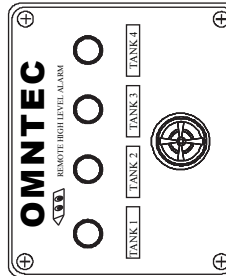

Internal Wiring Color Code

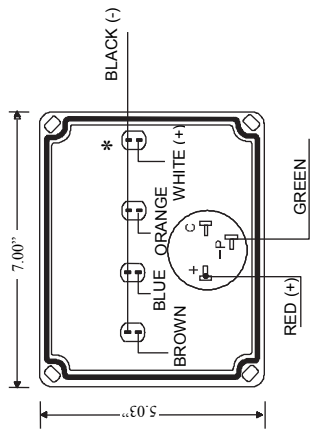
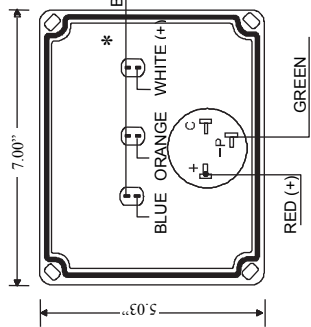
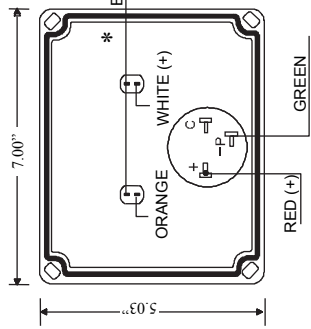
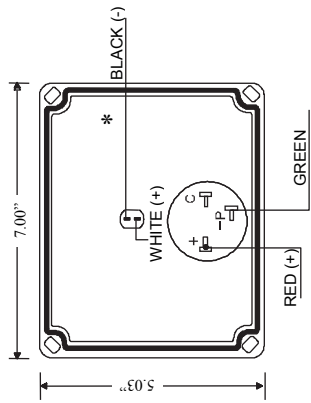

* **WARNING LABEL PLACED HERE:** Warning: Low voltage inputs only

SPECIFICATIONS	
Audible Alarm	95 dB pulsing horn
Red Light	Liquid-high-level alarm
Response Time	Immediate
Power Input	12VDC @200mA maximum from controller
Wire	22 AWG minimum
Weight	1 lb.

MOUNTING DIMENSIONS

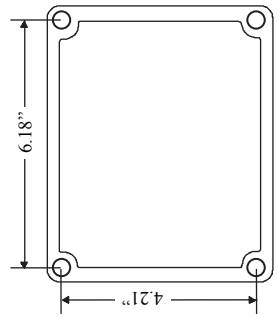

SIDE VIEW

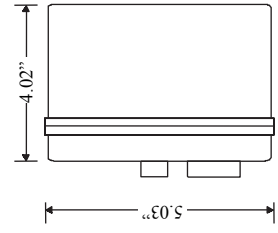

Note: It is recommended that knockouts be placed in the bottom of the enclosure

OWI-2 OIL WATER SEPARATOR

TYPICAL 2" FITTING ASSEMBLY

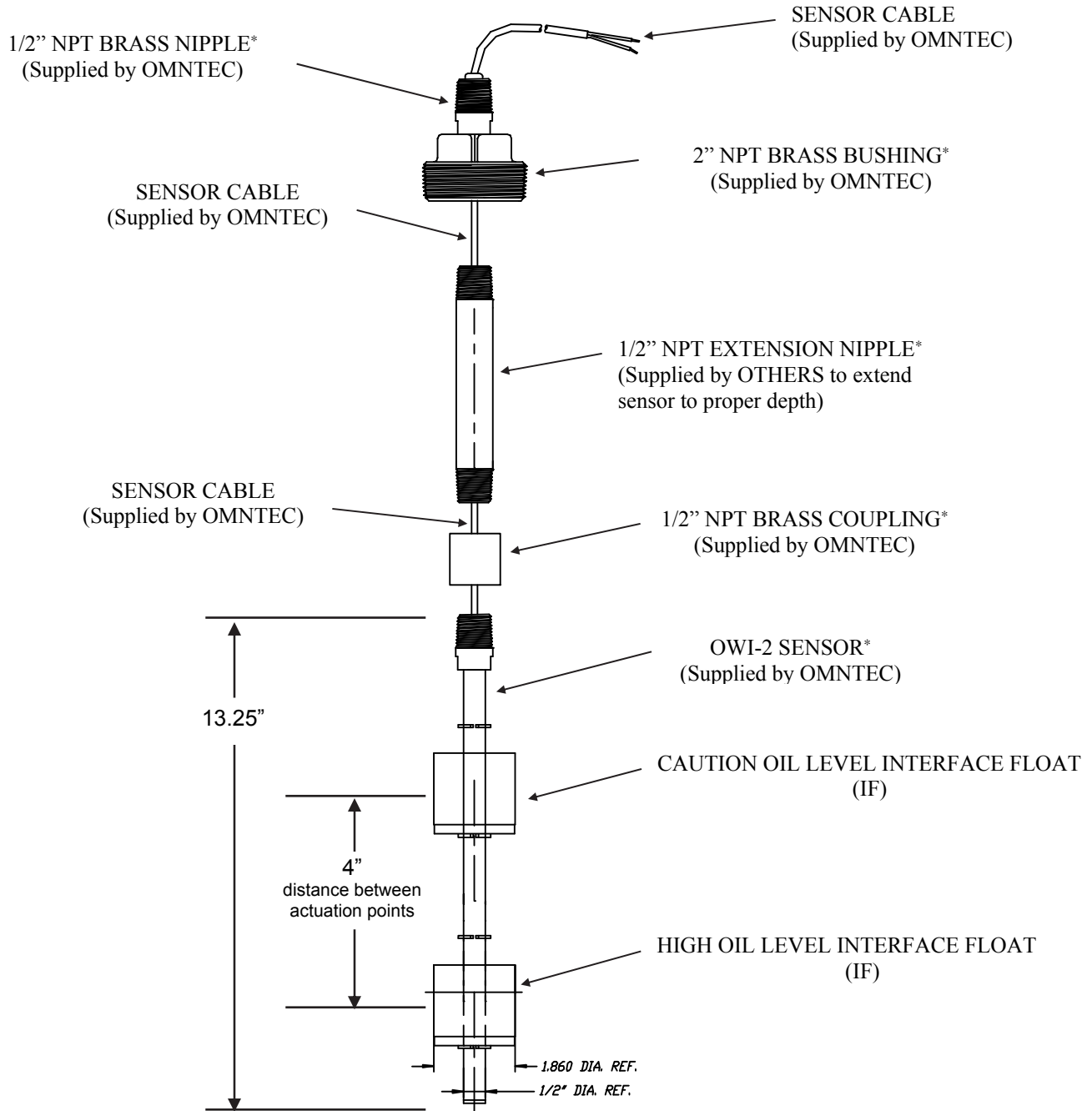

***WARNING-** It is the installer's responsibility to select a thread sealant that is compatible with the product being stored and that all NPT fittings are fastened properly to assure liquid tight seal for proper sensor operation.

OWI-2 OIL WATER SEPARATOR

TYPICAL MANWAY EXTENSION BRACKET INSTALLATION

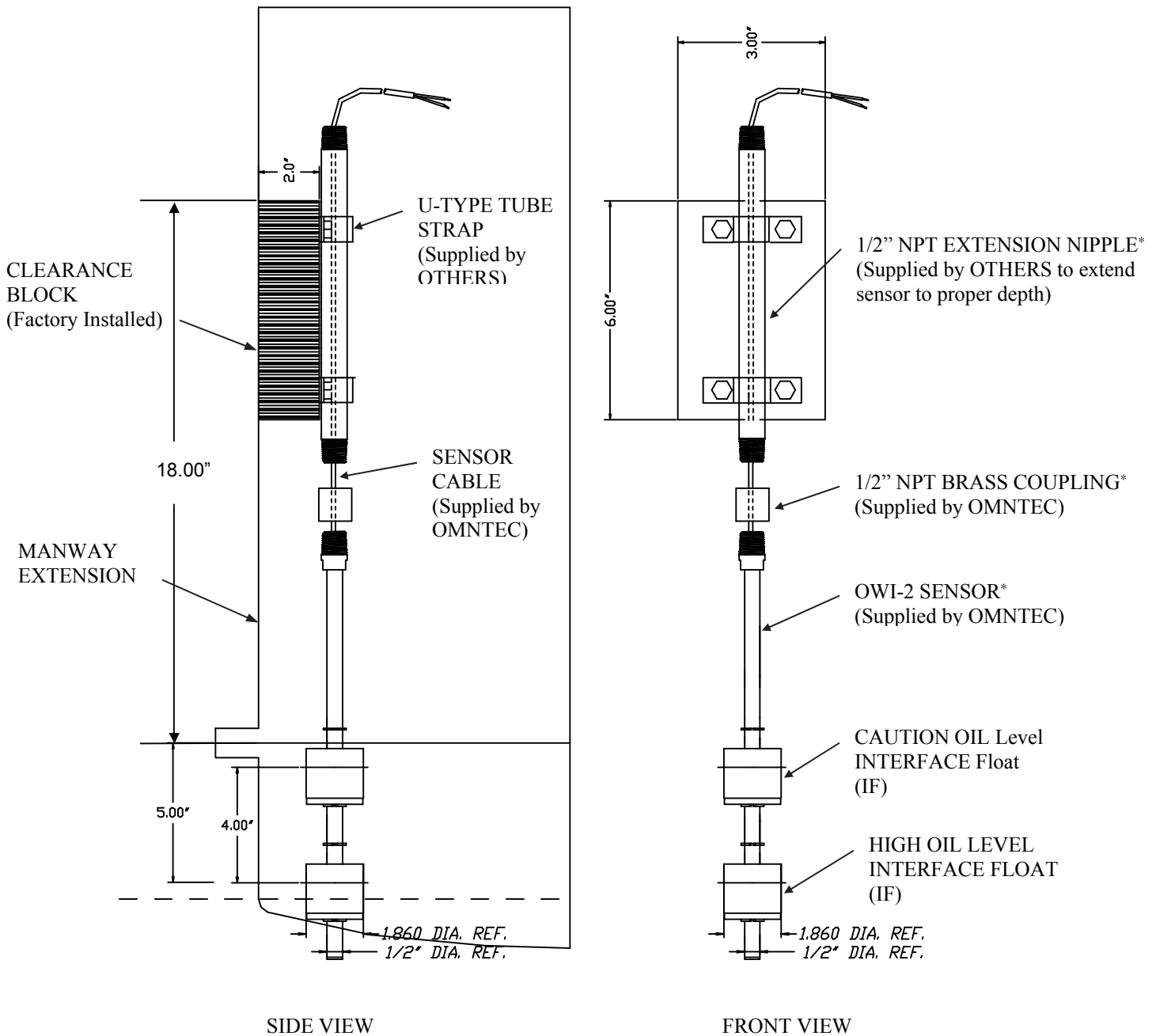

***WARNING-** It is the installer's responsibility to select a thread sealant that is compatible with the product being stored and that all NPT fittings are fastened properly to assure liquid tight seal for proper sensor operation.

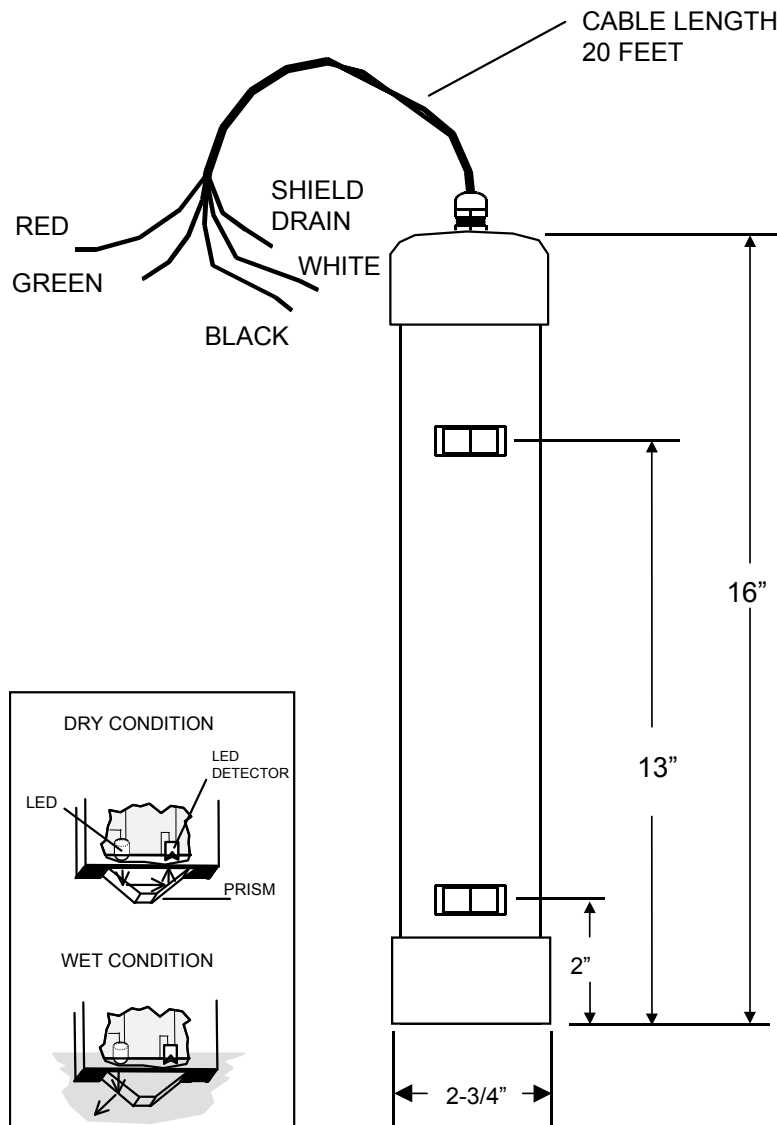
RESERVOIR SENSOR

L-R-1 SPECIFICATIONS
SOLID STATE (NO MOVING PARTS)

OPERATING TEMPERATURE

-40 TO +140 F

POWER

2 VDC @ 13 mA

WEIGHT

2 pounds

RESPONSE TIME

Immediate

PRINCIPLES OF OPERATION

LIQUIDS (ex: fuel, water) – Photo Optic

DRY CONDITION –

High level: Normally closed light beam

Low Level: Normally open light beam

ALARM CONDITION –

Hi level: Opens (refracts) normally closed light beam

Low level: Closes normally open light beam

SENSOR CABLE

Shielded 22 AWG UL-E118830 CM

Maximum length 2000 feet

TYPICAL RESERVOIR SENSOR INSTALLATION

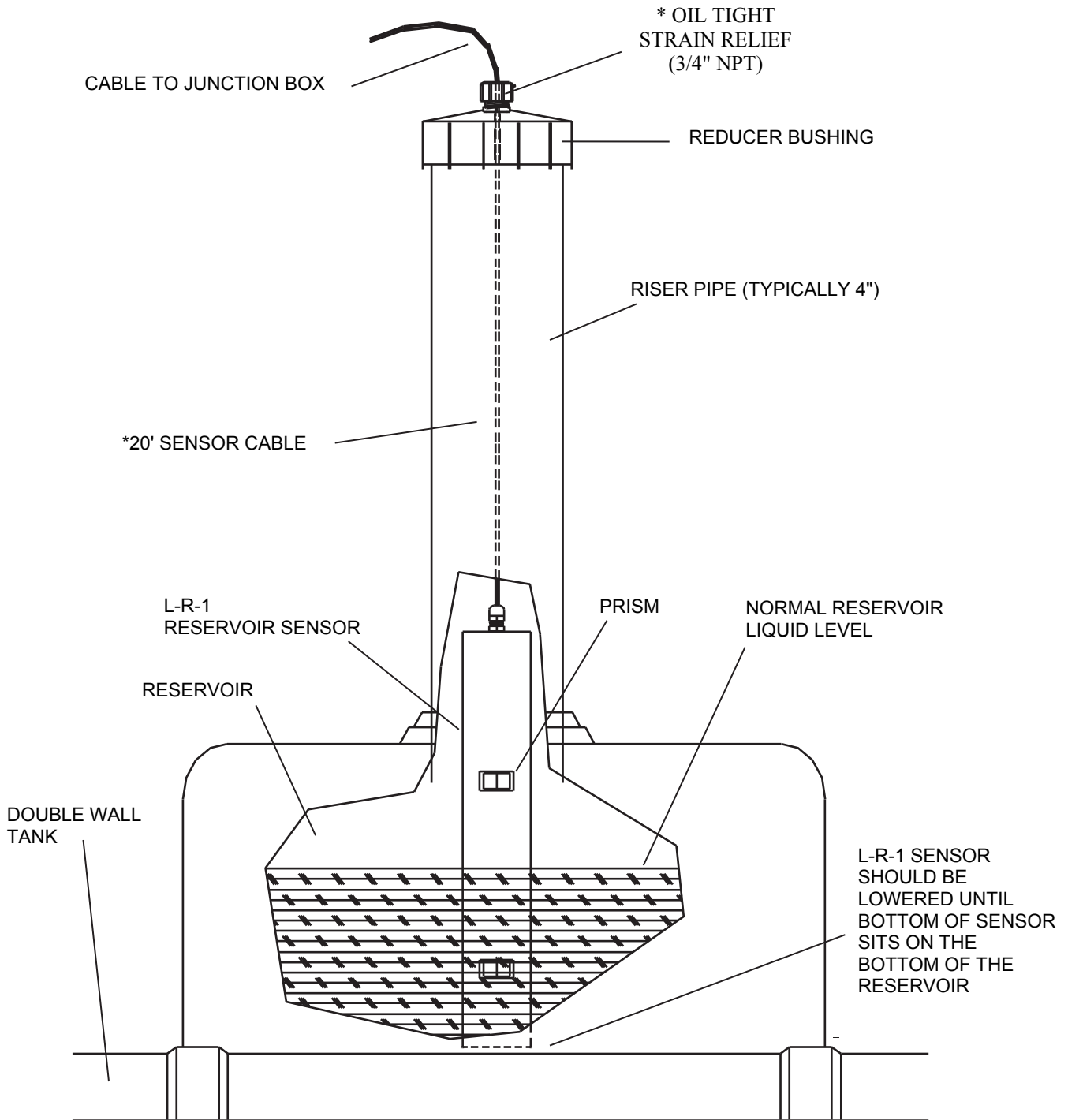

*SUPPLIED BY OMNTEC MFG., INC.

Product Distinguishing Optic Sensor

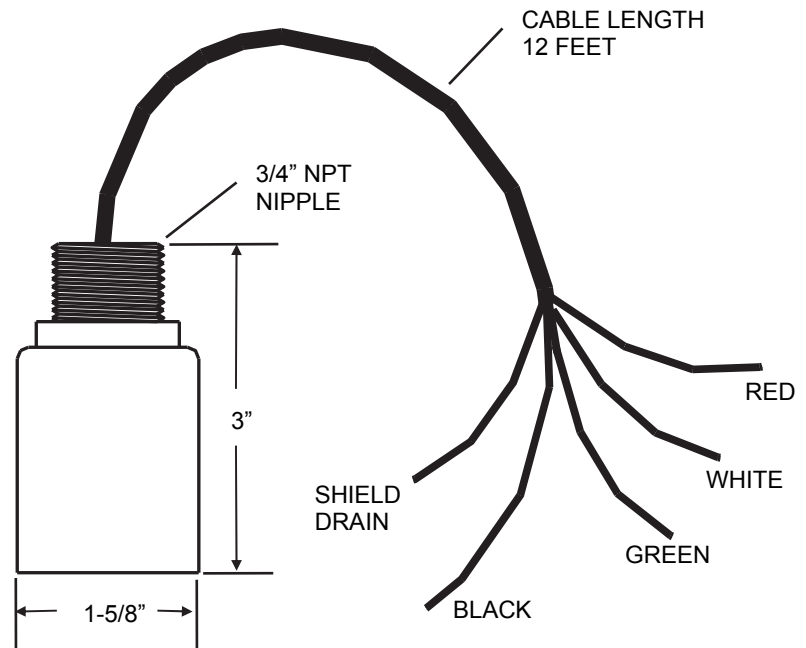
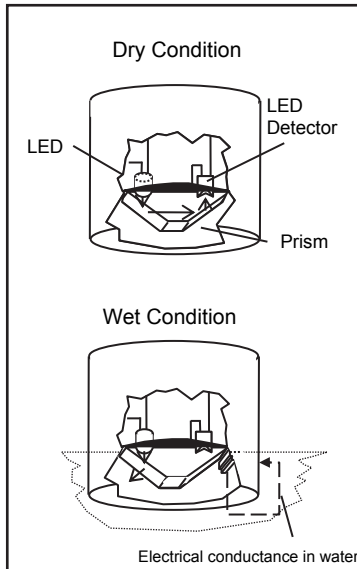
**PDS SPECIFICATIONS****U.L. LISTED 5L04**

Intrinsically safe Class I, Group D Hazardous Locations when connected in accordance with control drawing nos. L1PD2, L2PD4, L3PD6

OPERATING TEMPERATURE

-40° TO +140° F

POWER

2 VDC @ 13 mA

WEIGHT

1/2 pound

PRINCIPLES OF OPERATION

LIQUIDS (ex: fuel, water) – photo Optic

DRY CONDITION – Normally closed light beam

ALARM CONDITION – Opens (refracts) normally closed light beam

WATER DETECTION - conductance

SENSOR CABLE

Shielded 22 AWG UL-E118830 CM

Maximum length 2000 feet

RESPONSE TIME

Immediate

Product Distinguishing Steel Tank Dry Interstitial Sensor

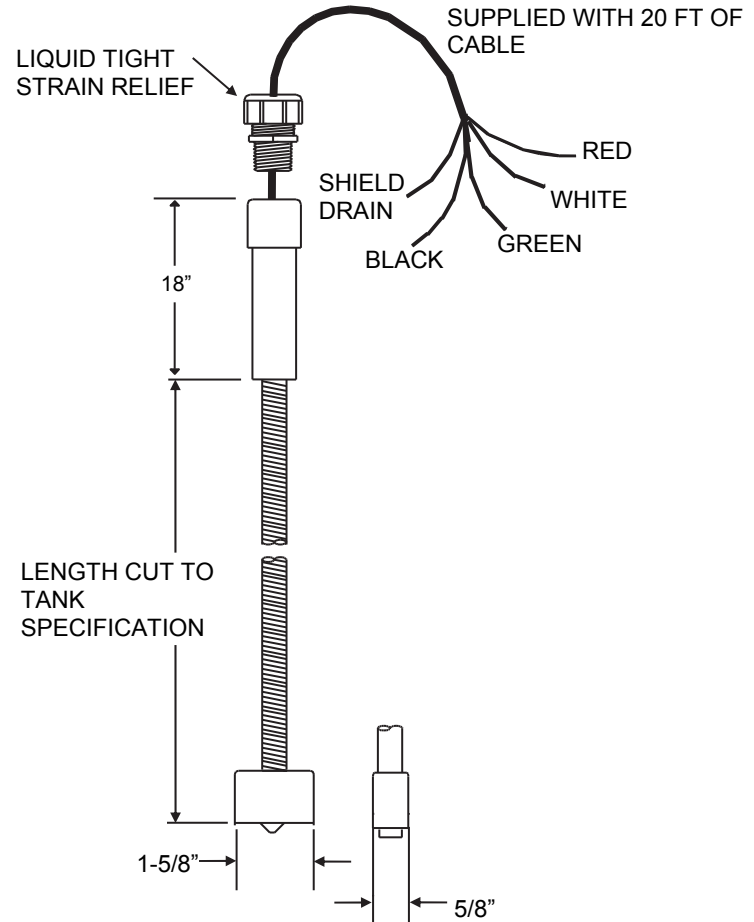
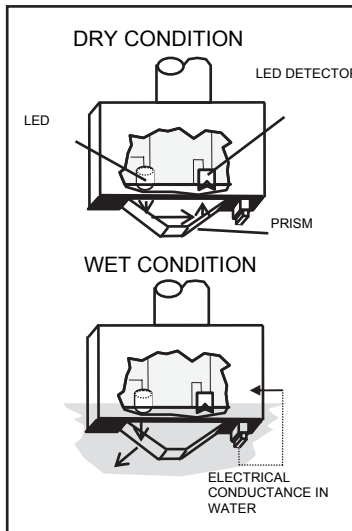
**PDWF SPECIFICATIONS****U.L. LISTED 5L04**

Intrinsically safe Class I, Group D Hazardous Locations when connected in accordance with control drawing nos. L1PD2, L2PD4, L3PD6

OPERATING TEMPERATURE

-40° TO +140° F

POWER

2 VDC @ 13 mA

WEIGHT

1/2 pound

PRINCIPLES OF OPERATION

LIQUIDS (ex: fuel, water) – photo Optic
 DRY CONDITION – Normally closed light beam
 ALARM CONDITION – Opens (refracts) normally closed light beam
 WATER DETECTION - conductance

SENSOR CABLE

Shielded 22 AWG UL-E118830 CM
 Maximum length 2000 feet

RESPONSE TIME

Immediate

LOG SHEET

DATE	NAME	SYSTEM STATUS	SIGNATURE

WARRANTY

The seller OMNTEC Mfg., Inc. warrants to buyer defects when properly installed, and maintained by user. The sellers sole obligation is to repair or replace parts found to be defective, or non-conforming for one year and only after evaluation by factory. The liability of the seller shall not exceed the price paid for the components found to be defective. The above warranty is exclusive of all other warranties whether implied or expressed. Seller assumes no obligation for special or, indirect damages incurred by user.

All standard tank gauging systems are free of defects when properly installed and maintained by user. Warranty on tank gauging systems will only be effective after proper documentation has been submitted by the buyer to OMNTEC Mfg., Inc. The sellers sole obligation is to repair or replace parts found to be defective, or non-conforming for one year and only after evaluation by factory. The liability of the seller shall not exceed the price paid for the components found to be defective. The above warranty is exclusive of all other warranties whether implied or expressed. Seller assumes no obligation for special or indirect damages incurred by user.

All standard replacement parts, "add-ons", or spare parts are free of defects when properly installed and maintained by user. The sellers sole obligation is to repair or replace parts found to be defective or non-conforming for 90 days and only after evaluation by factory. The liability of the seller shall not exceed the price paid for the components found to be defective. The above warranty is exclusive of all other warranties whether implied or expressed. Seller assumes no obligation for special or indirect damages incurred by user.

Equipment not covered by this warranty includes, but is not limited to: custom equipment, pressure transducers, and control systems.